

CHANNEL BLOCK WITH LOG FRAME

Plan View

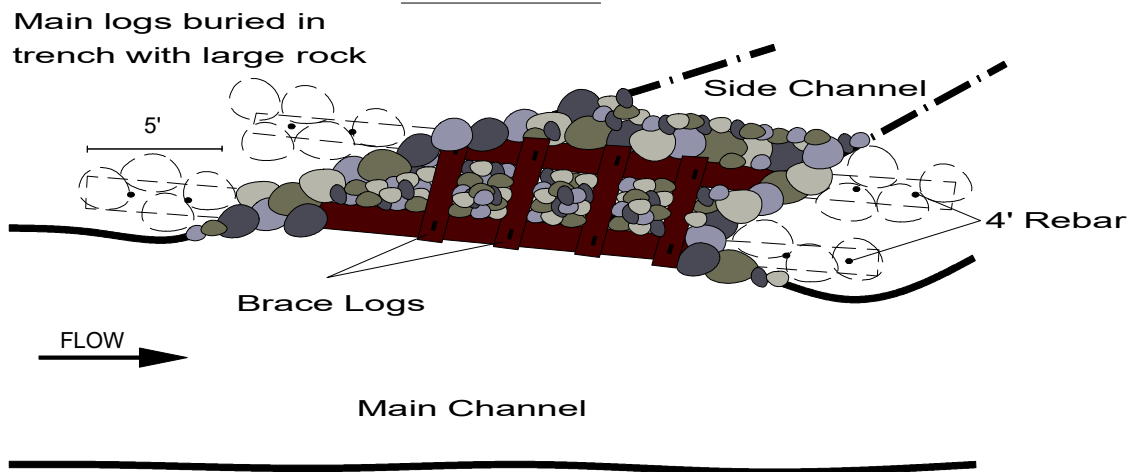

Section View

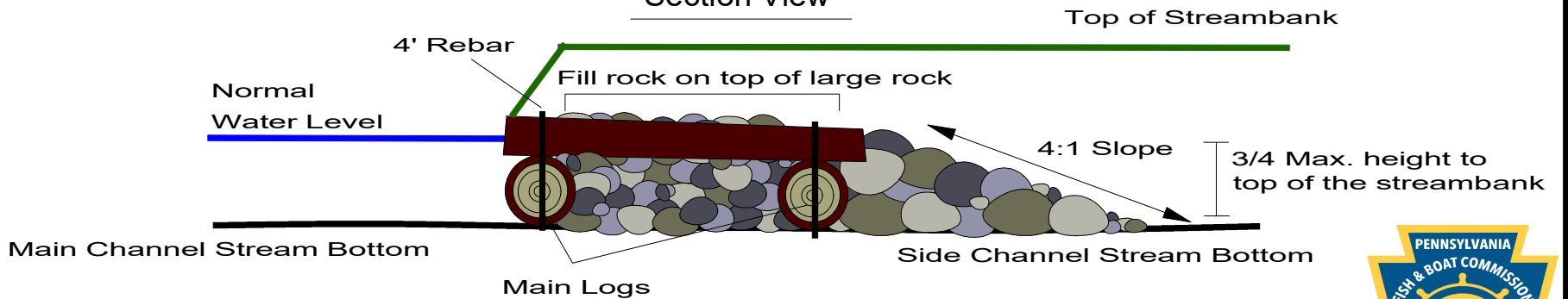

Note: Channel block built lower than surrounding streambanks while maintaining normal water level height
Maximum device height is 3/4 to the top of the bank



CHANNEL BLOCK WITH ROOTWADS

Plan View

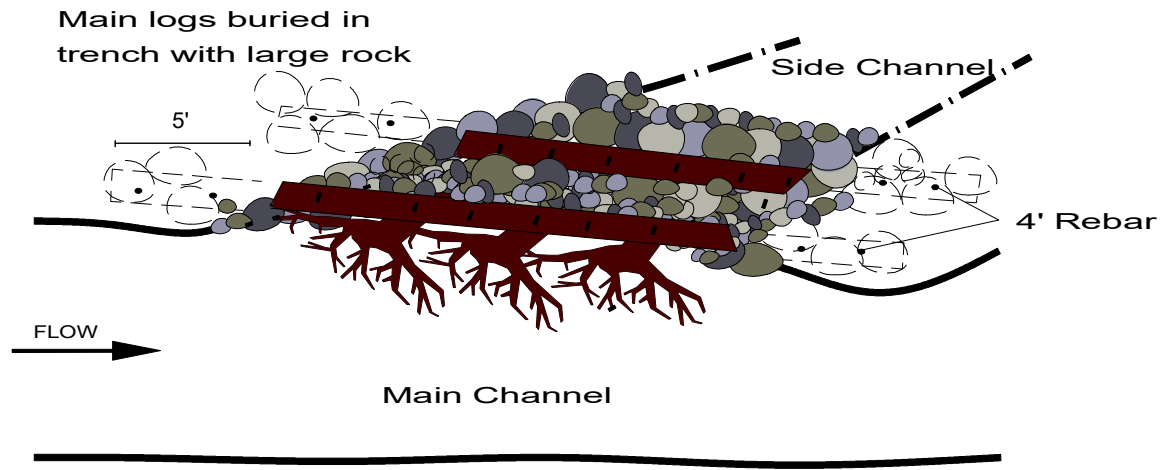

Section View

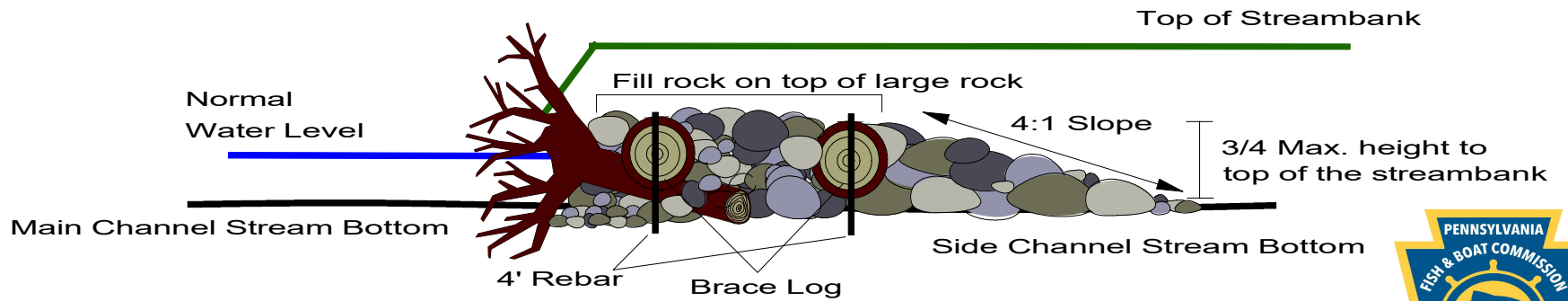

Note: Channel block built lower than surrounding streambanks while maintaining normal water level height
Maximum device height is 3/4 to the top of the bank



CHANNEL BLOCK WITH SINGLE LOGS AND ROOTWADS

Plan View

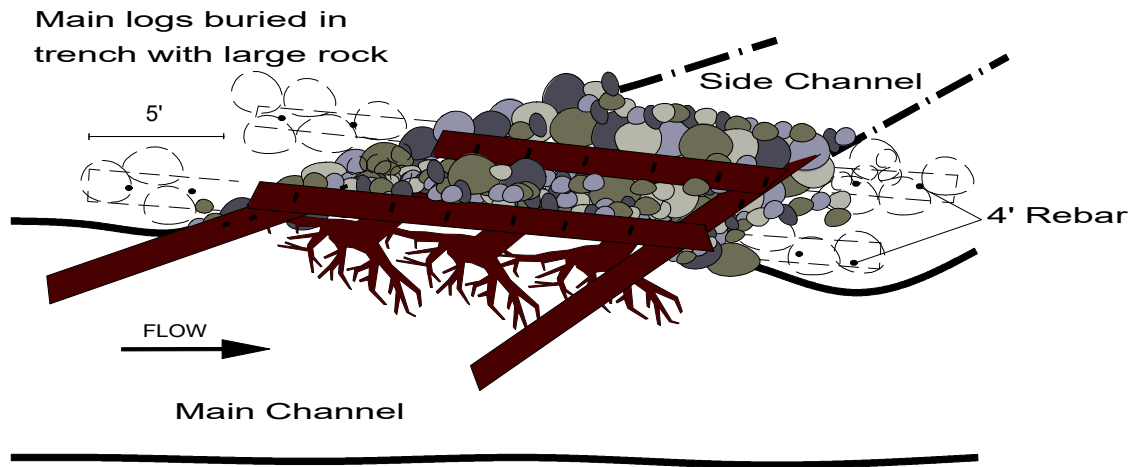

Section View

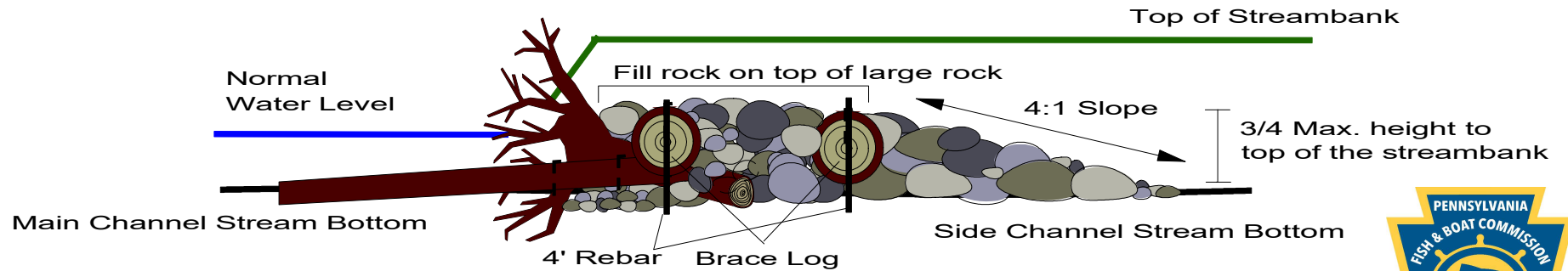

Note: Channel block built lower than surrounding streambanks while maintaining normal water level height
Maximum device height is 3/4 to the top of the bank



CHANNEL BLOCK WITH STONE

Plan View

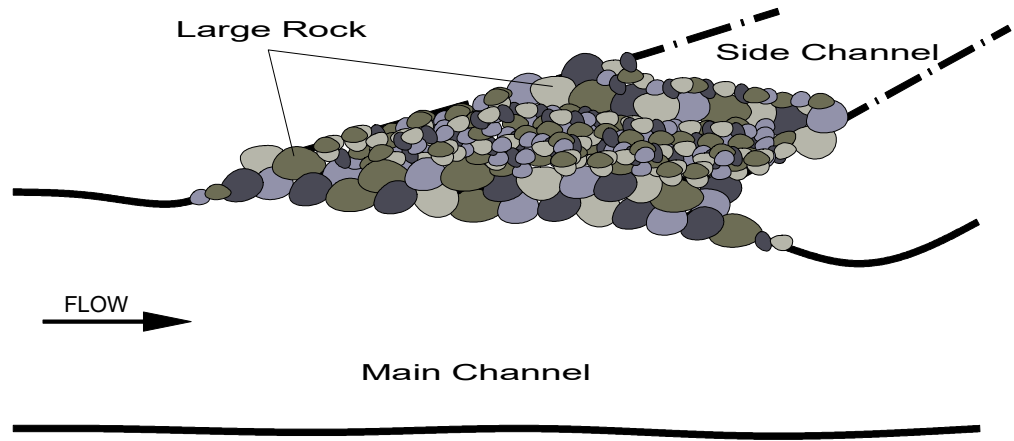

Section View

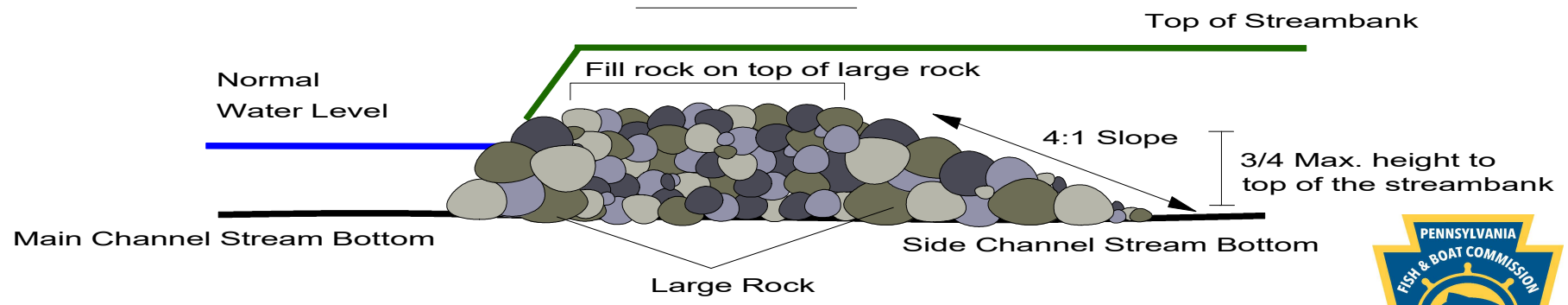

Note: Channel block built lower than surrounding streambanks while maintaining normal water level height
Maximum device height is 3/4 to the top of the bank



BRUSH DEFLECTOR (LOW GRADIENT STRUCTURE)

Plan View

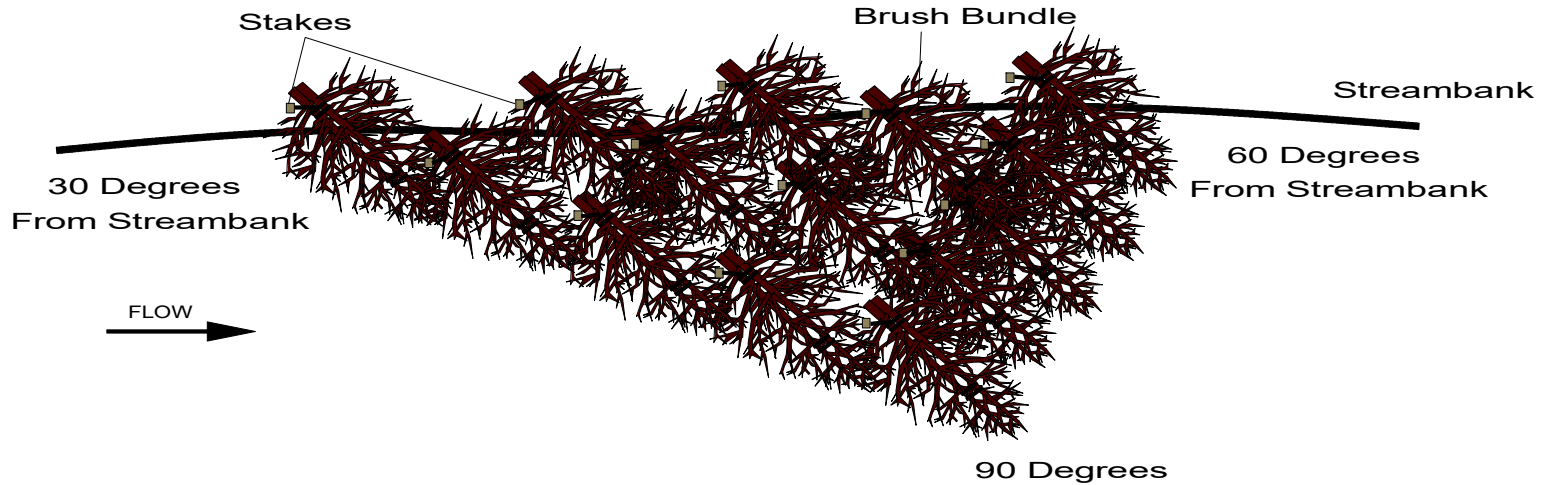

Section View

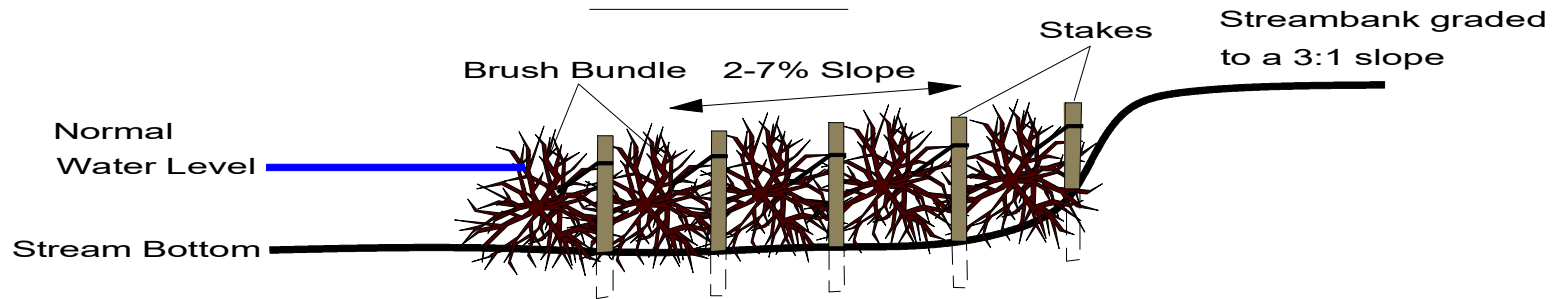

Note: Christmas tree/brush bundles attached to stakes and to other bundles with natural fiber twine
Stakes must be made of wood or other natural material

Note: Recommended only for use in low gradient systems

DHM, PFBC 2022



LOG FACED STONE DEFLECTOR

Plan View

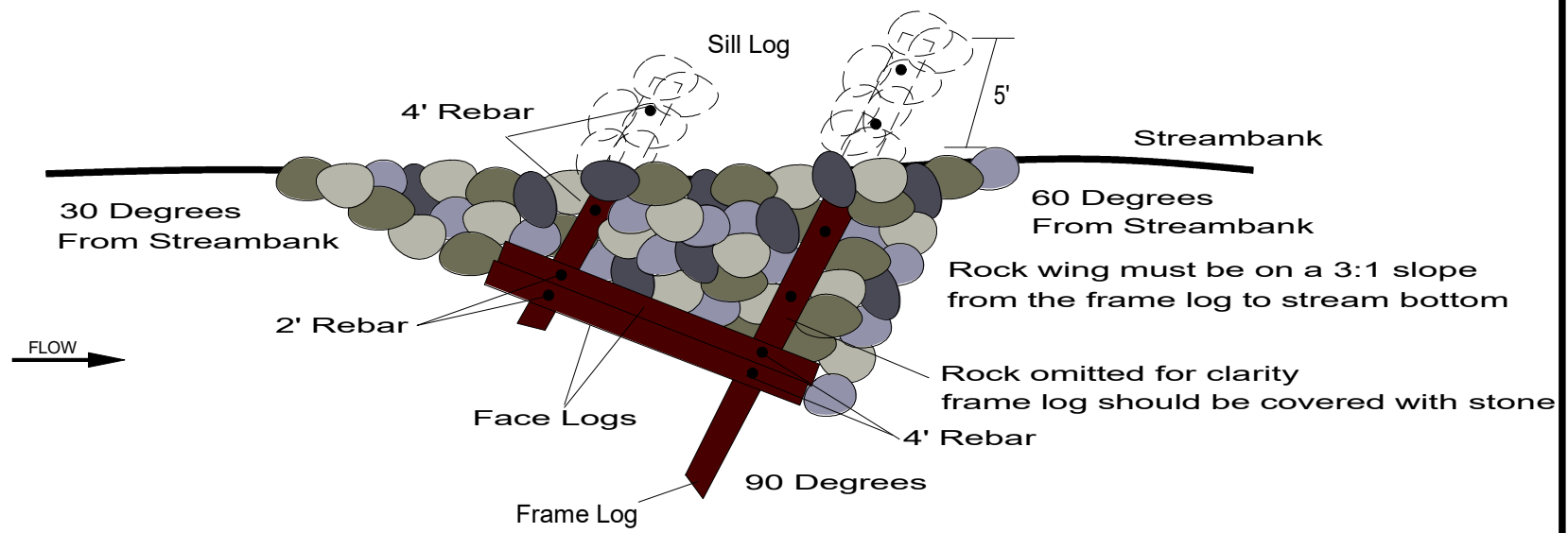

Section View

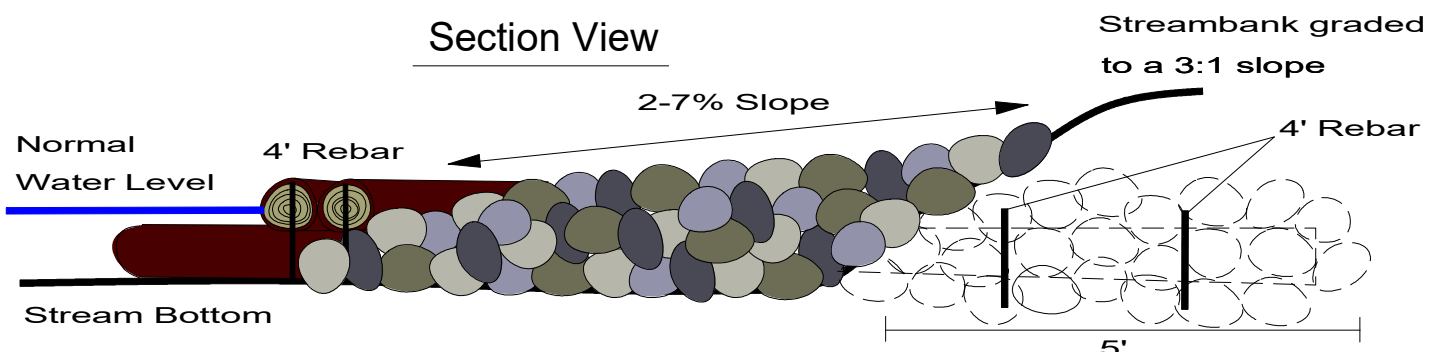

- Sill Logs = 10-15'
- Face Logs = 20'
- Frame Log = 20-30'
- Log Dia. = 8-12"



LOG FRAMED DEFLECTOR WITH BOARDS

Plan View

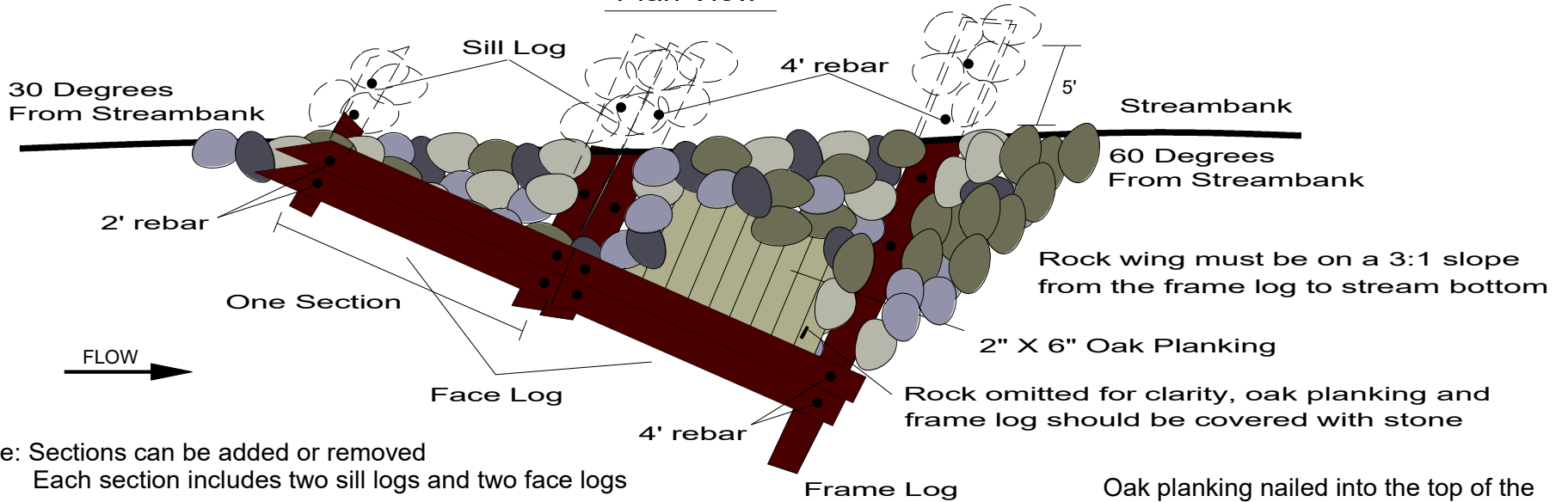

Note: Sections can be added or removed
Each section includes two sill logs and two face logs

Section View

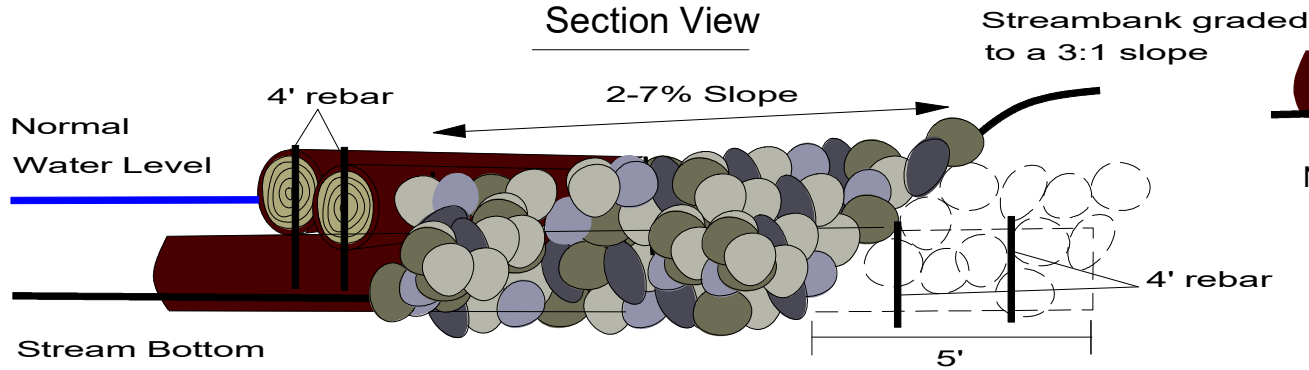

Oak planking nailed into the top of the back log and buried into streambank

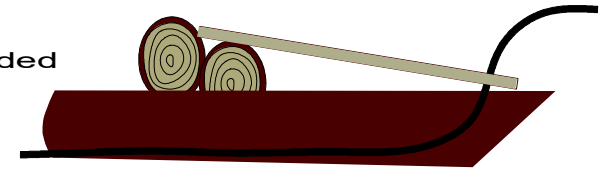

Note: Front face log kept higher to protect edge of oak planks

- Sill Logs = 10-15'
- Face Logs = 20'
- Frame Logs = 20'-30'
- Log Dia. = 8-12"

Frame log buried in trench with rock



LOG FRAMED STONE DEFLECTOR

Plan View

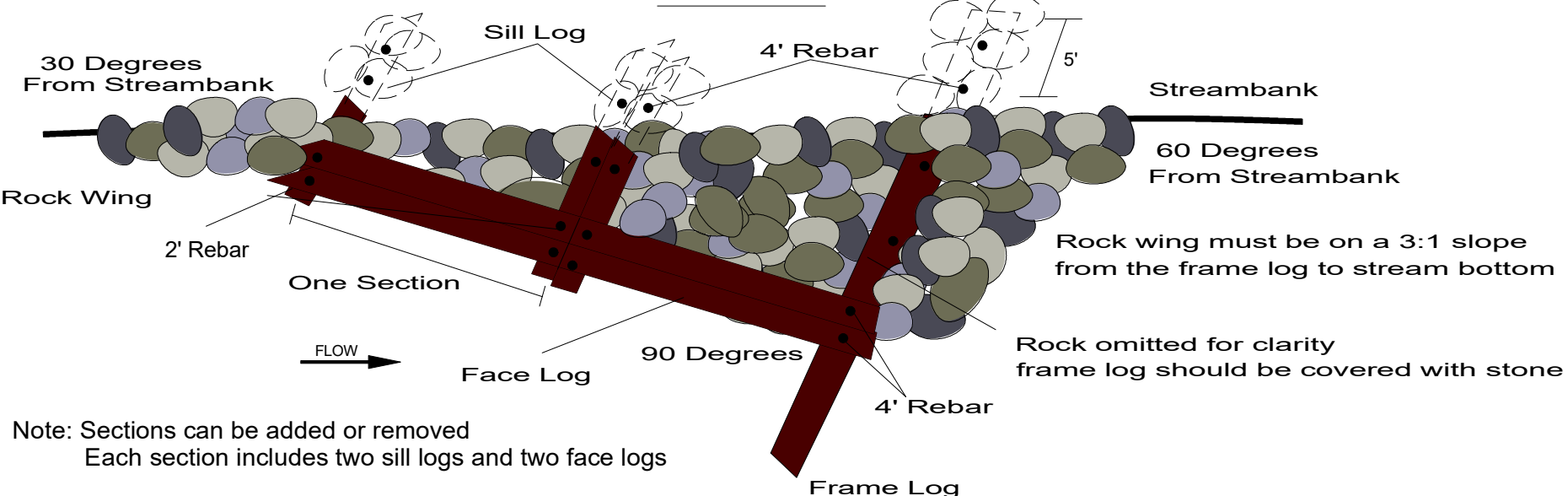

Note: Sections can be added or removed
Each section includes two sill logs and two face logs

Section View

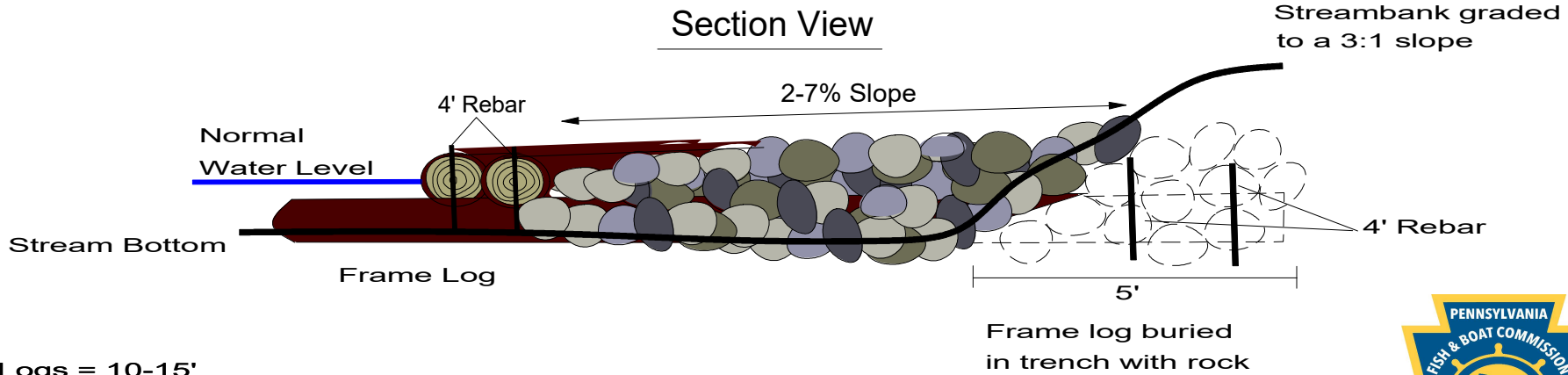

- Sill Logs = 10-15'
- Face Logs = 20'
- Log Dia. = 8-12"



OPEN CENTER STONE DEFLECTOR WITH LOGS

(LOW GRADIENT STRUCTURE)

Plan View

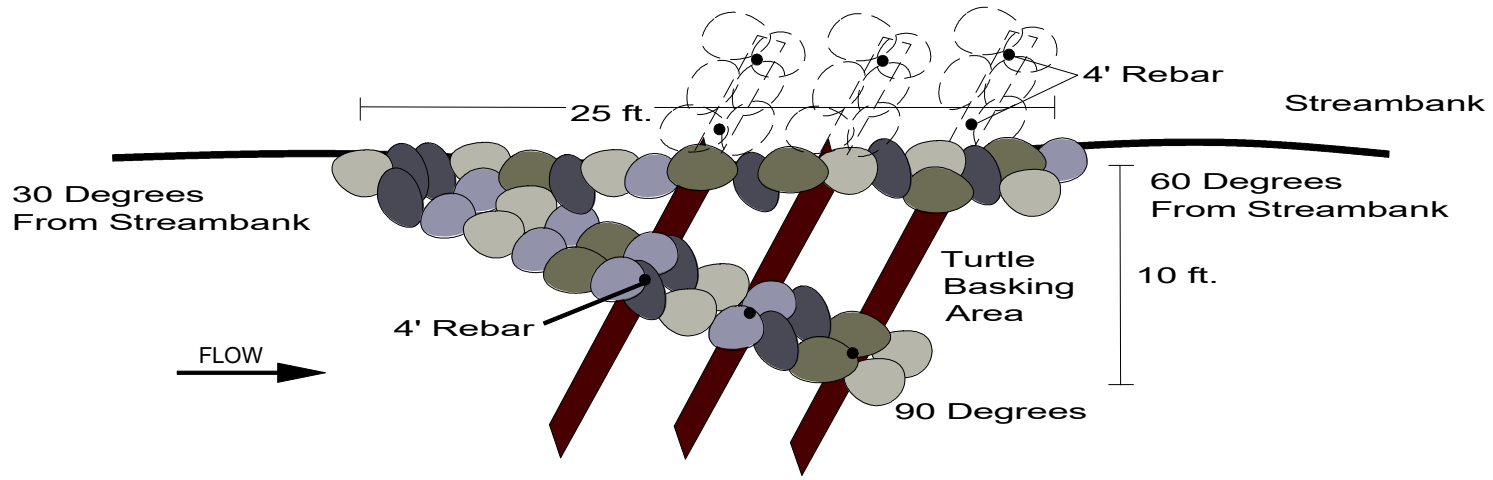

Note: Length measurement is 2.5 times the width
Deflector sizes may vary

Section View

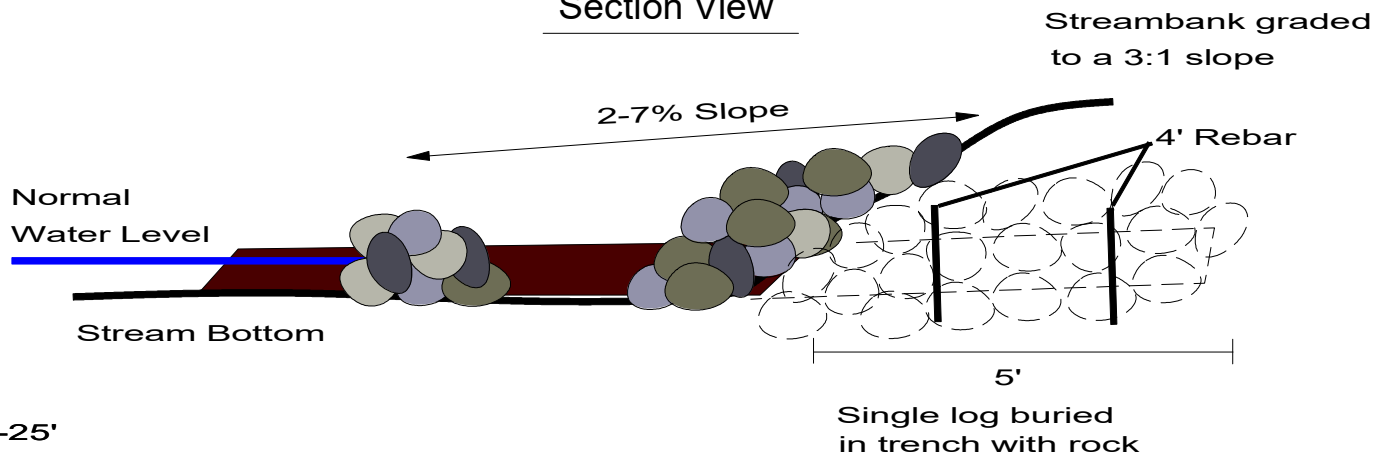

Log Length = 15-25'

Log Dia. = 8-12"

Note: Recommended only for use in low gradient systems

DHM, PFBC 2022



RANDOM BOULDER PLACEMENT

Plan View

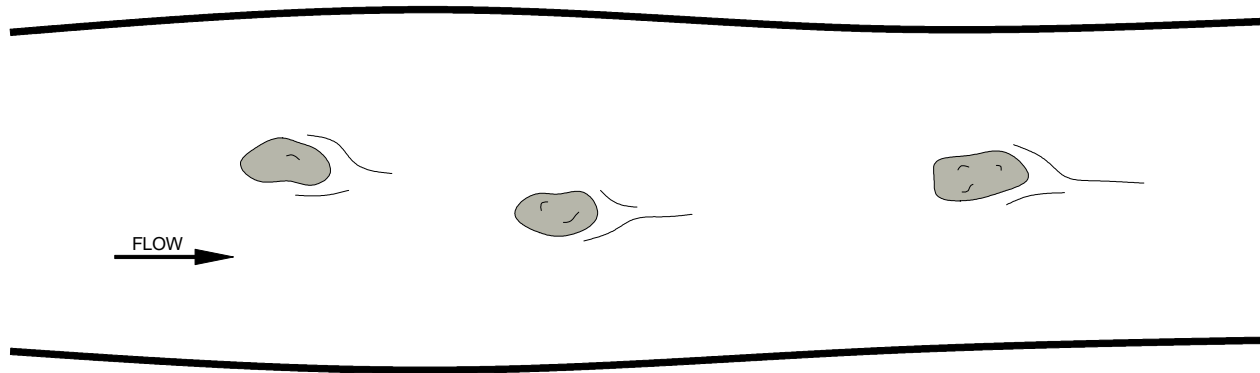

Note: Place boulders in the middle third of the wetted width of the stream to prevent flow deflection into the streambanks

Section View

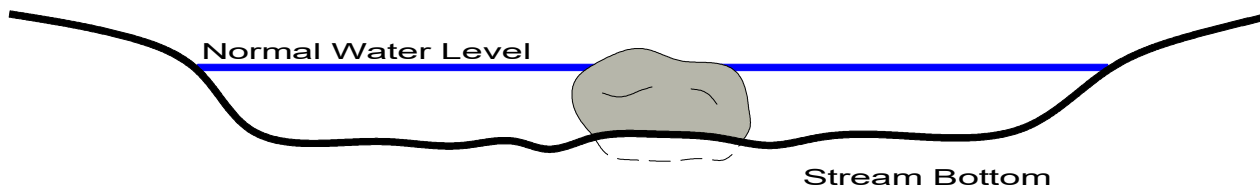

Note: Boulder should be large enough not to be displaced during high flow periods
Boulder height should be within 2" of normal water level



ROOTWAD DEFLECTOR

Plan View

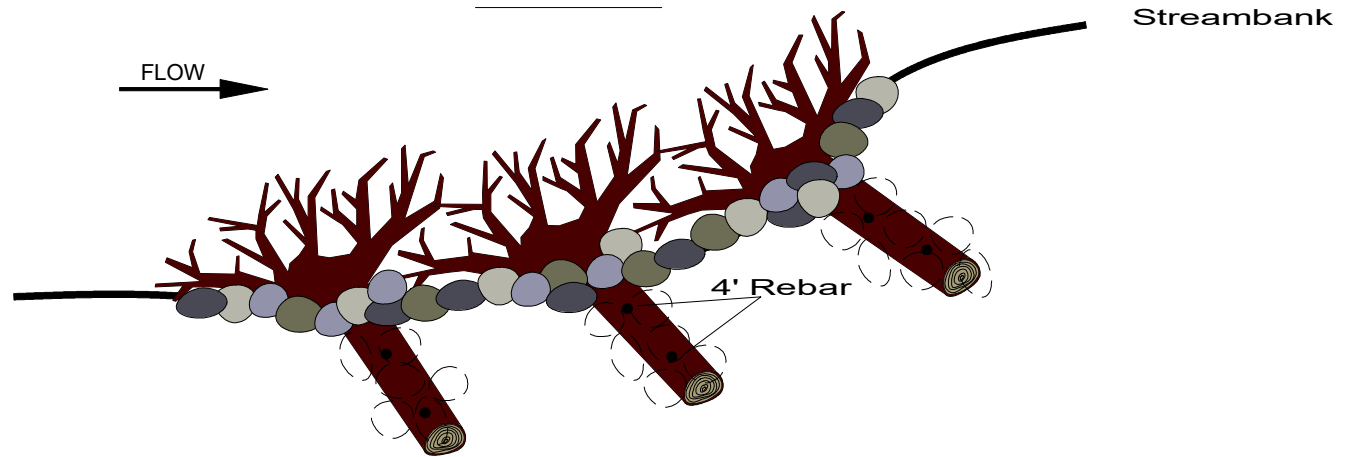

Note: Can be placed as a single deflector or overlapping as shown

Section View

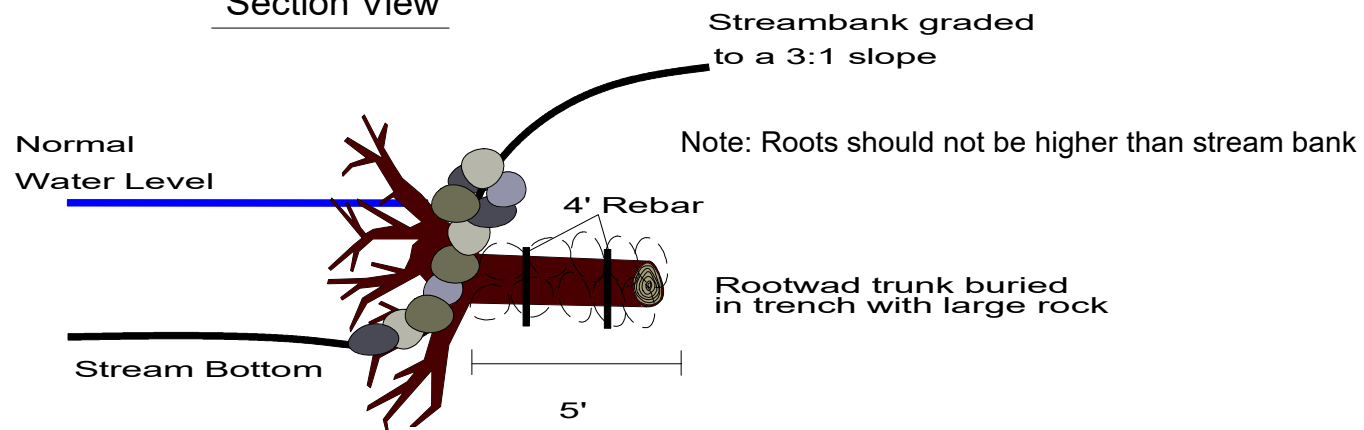

Rootwad Dia. = 3-6'
Rootwad Length = 10-15'



SAWTOOTH STONE DEFLECTORS WITH LOGS

Plan View

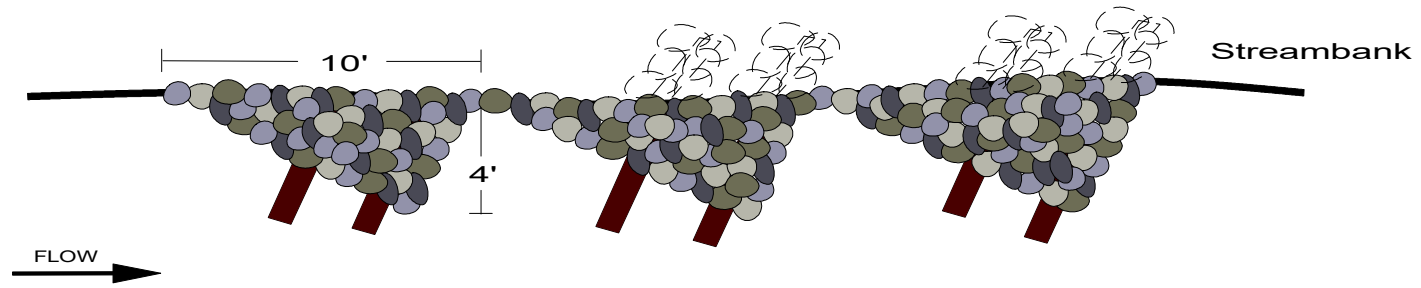

Note: Logs should be protruding 2 to 3 feet from rock face

Section View

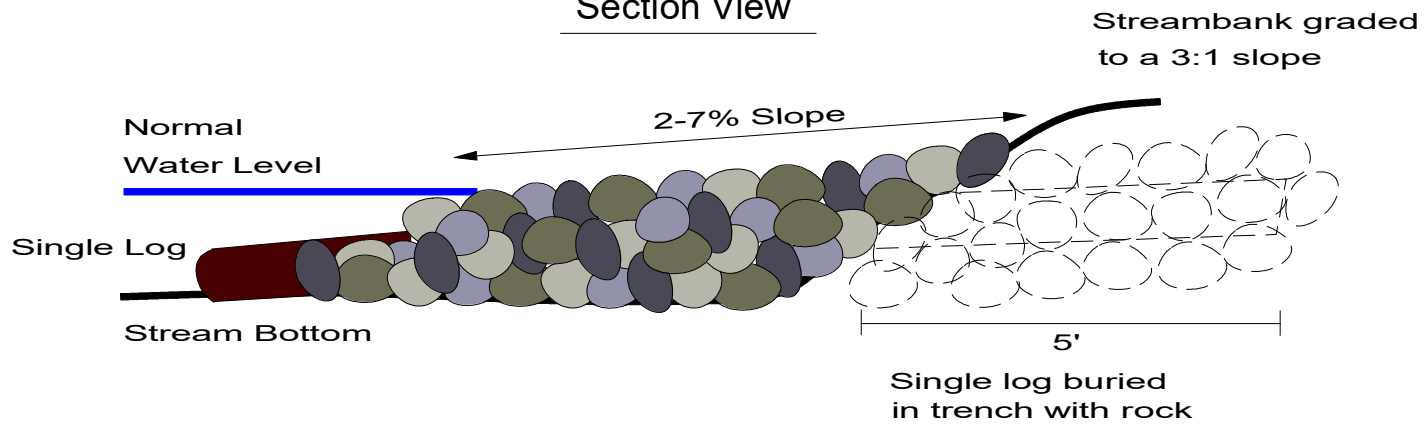

Log Length = 10-15'

Log Dia. = 8-12"

DHM, PFBC 2022



SAWTOOTH STONE DEFLECTORS

Plan View

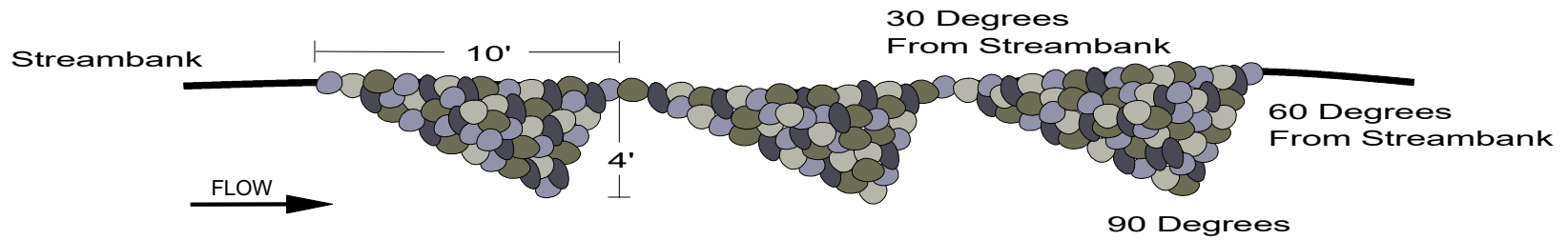

Note: Sections can be added or removed and the length measurement is 2.5 times the width

Section View

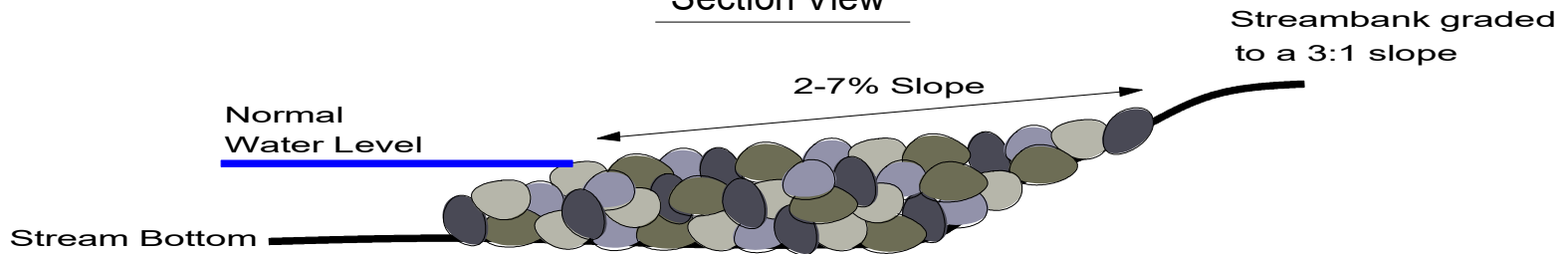

STONE DEFLECTOR WITH ROOTWADS

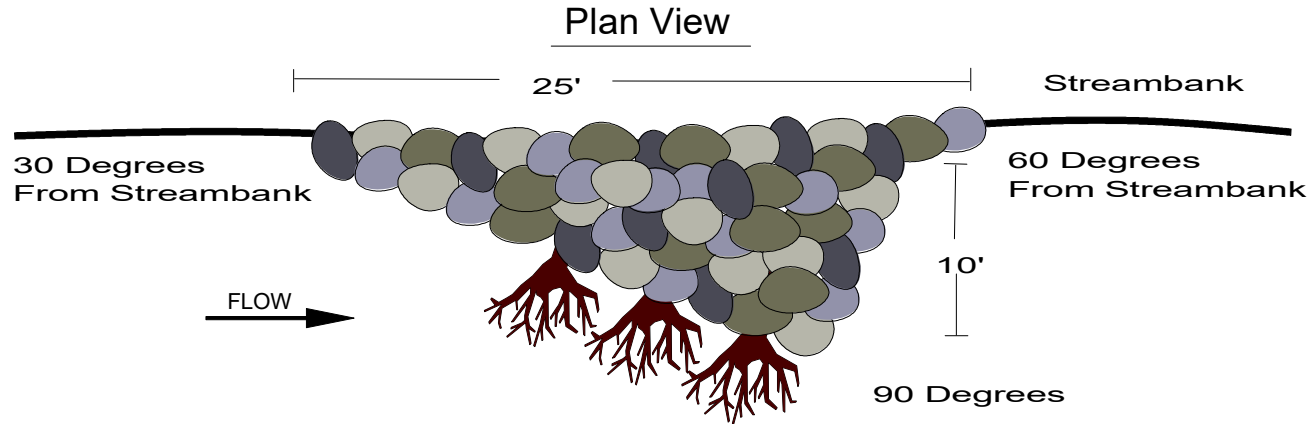

Note: Length measurement is 2.5 times the width
Deflector sizes may vary

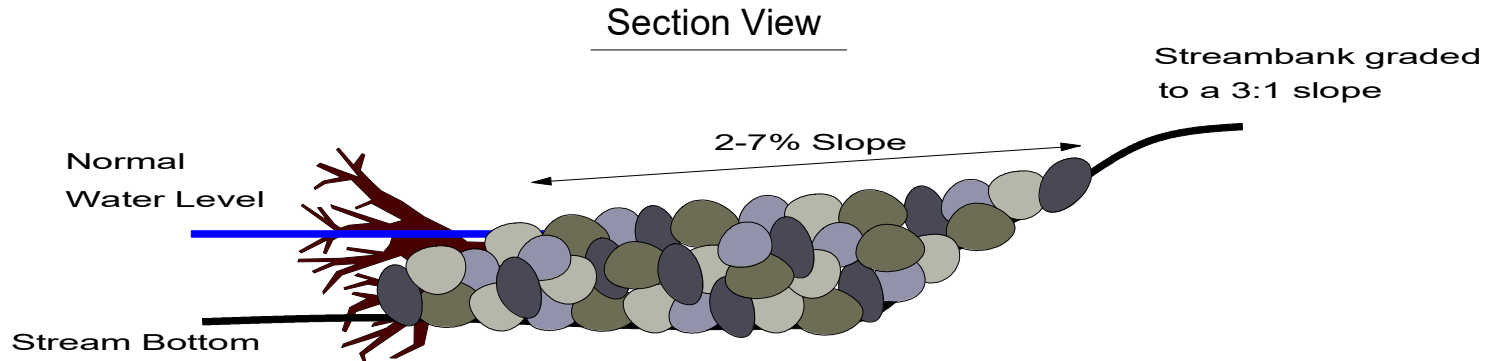

Rootwad Dia. = 3-6'
Rootwad Length = 10-15'



STONE DEFLECTOR WITH SINGLE LOG AND J-HOOK

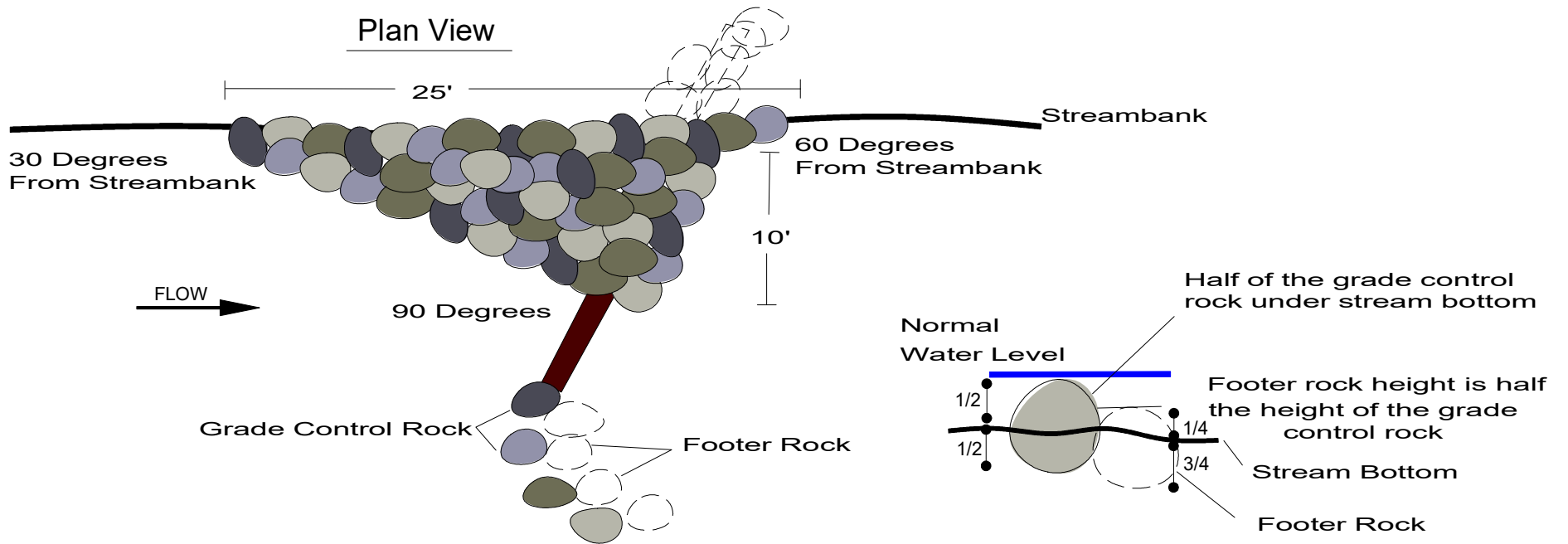

Note: Length measurement is 2.5 times the width
Deflector sizes may vary

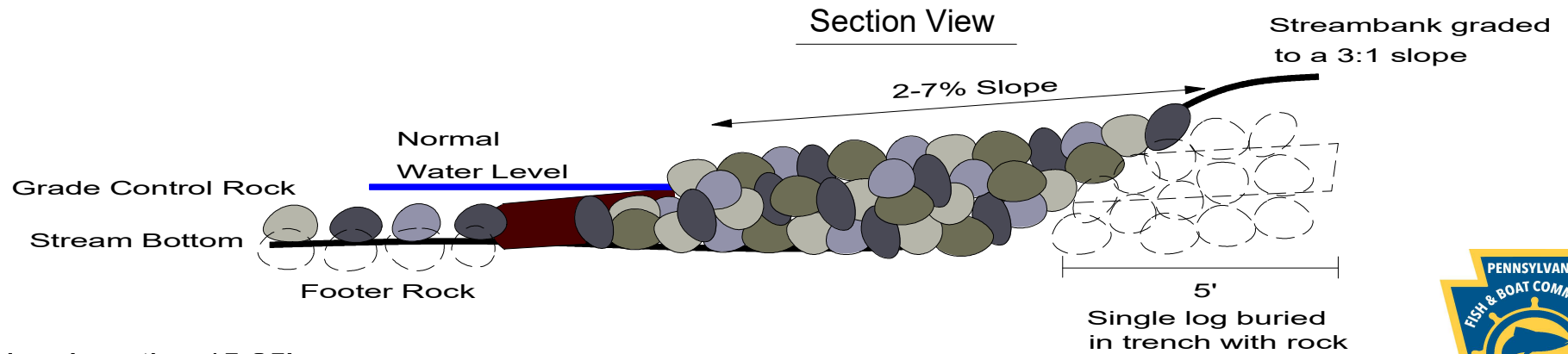

Log Length = 15-25'
Log Dia. = 8-12"



STONE DEFLECTOR WITH SINGLE LOG

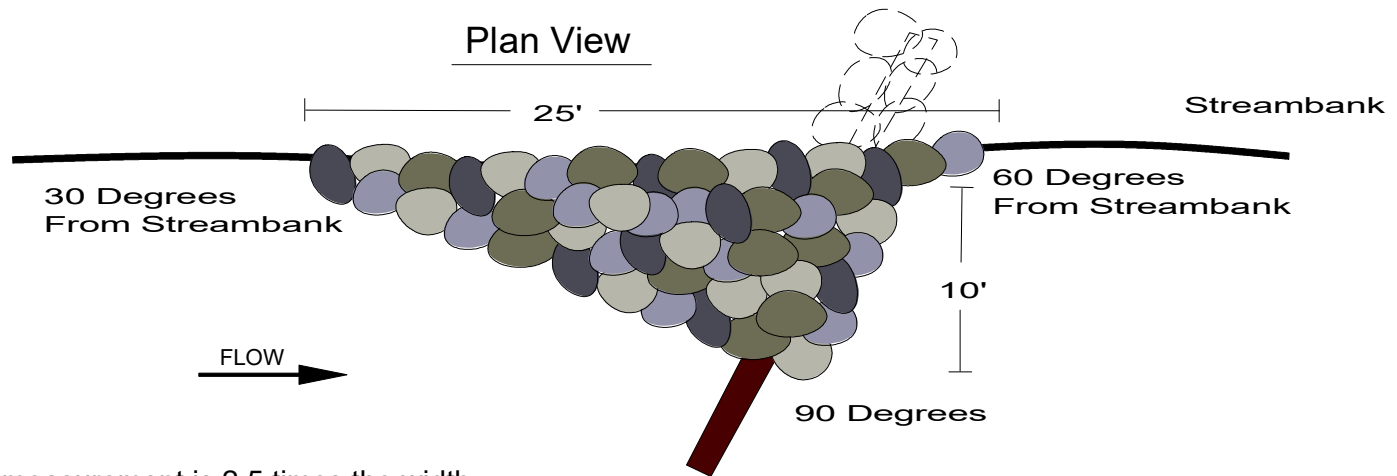

Note: Length measurement is 2.5 times the width
Deflector sizes may vary

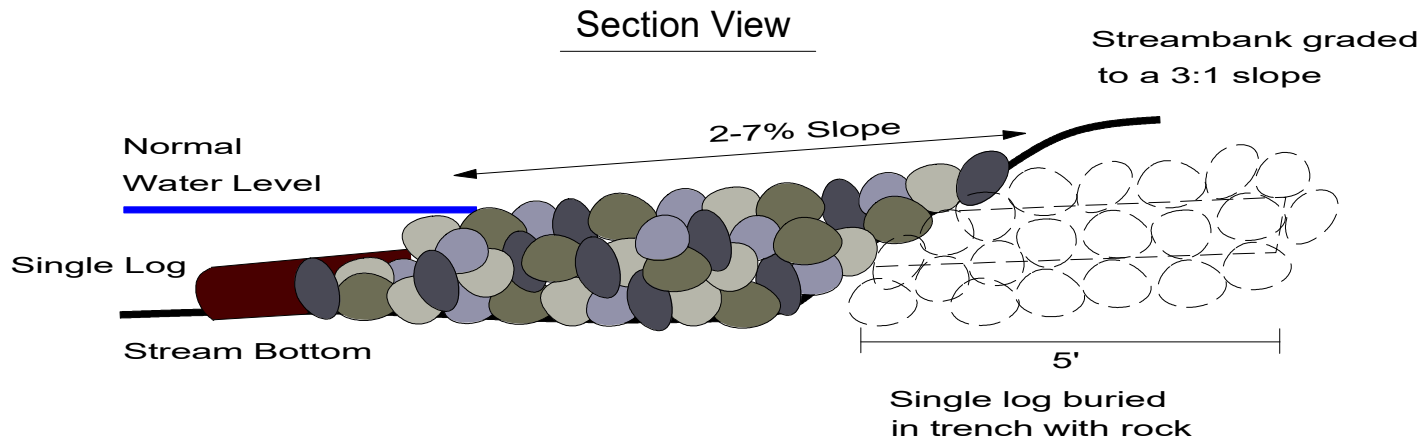

Log Length = 15-25'

Log Dia. = 8-12"

DHM, PFBC 2022



STONE DEFLECTOR

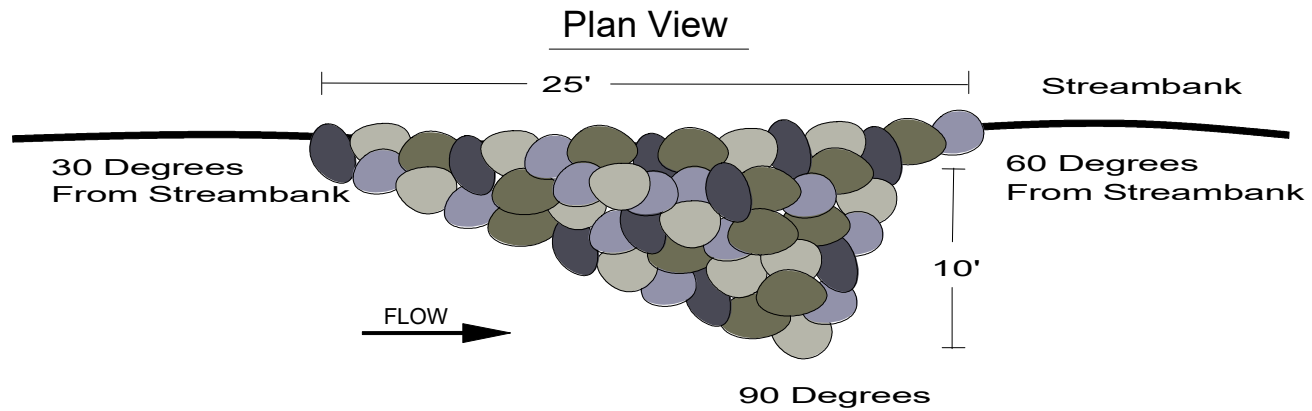

Note: Length measurement is 2.5 times the width
Deflector sizes may vary

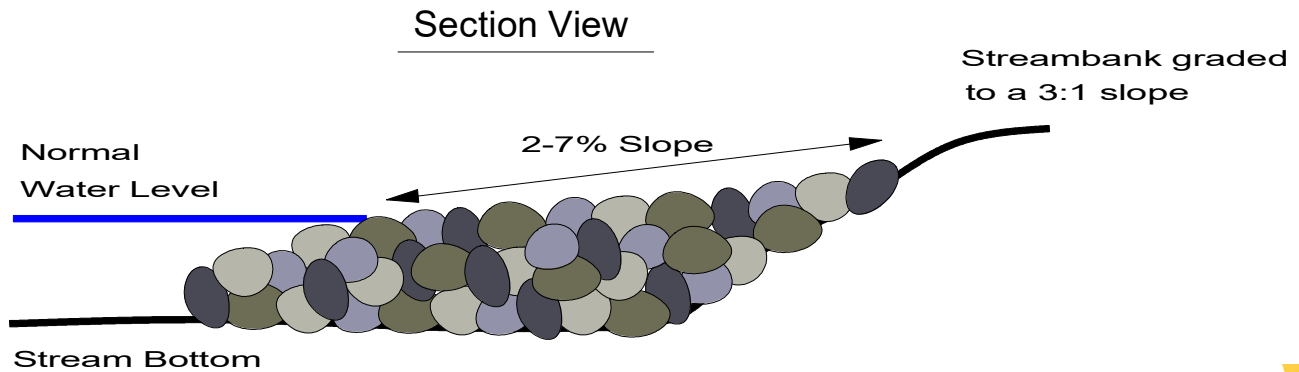

LARGE WOOD DEVICES

Plan View

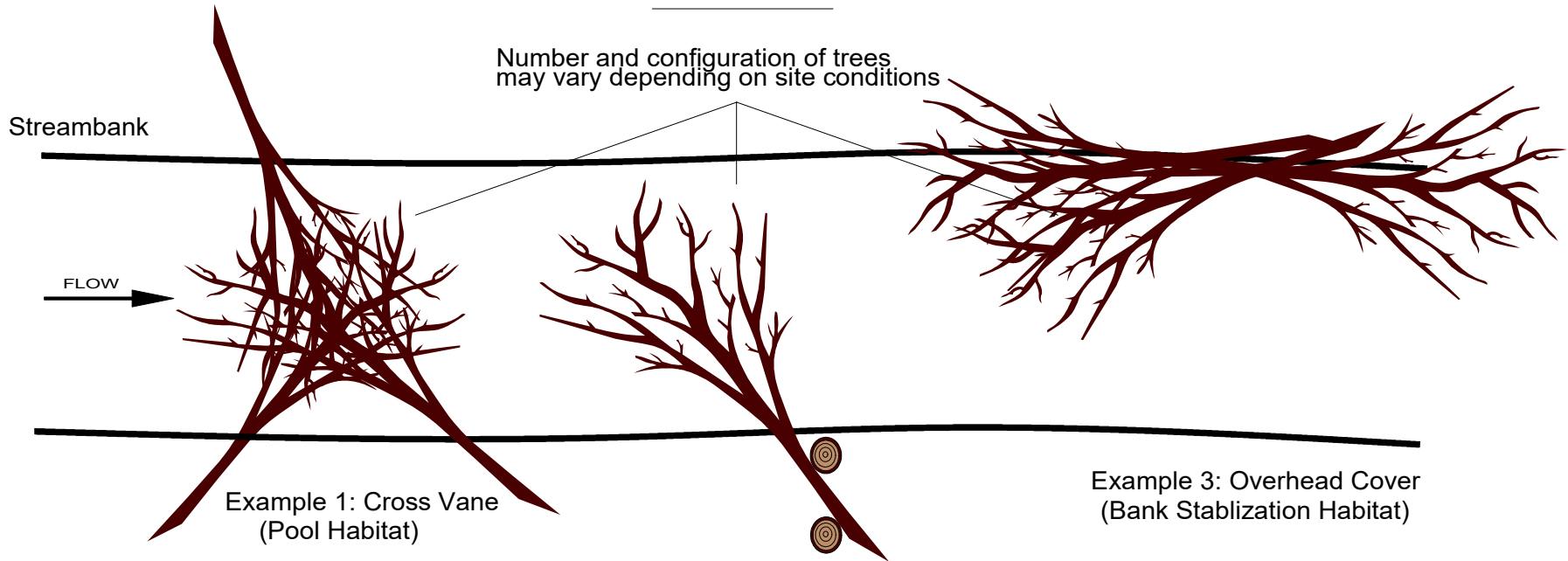

Note: Trees should be large enough and have enough ballast to prevent movement during high flow periods

Note: When possible trees should be "pinned" between stumps and or living trees to reduce likelihood of movement

Section View

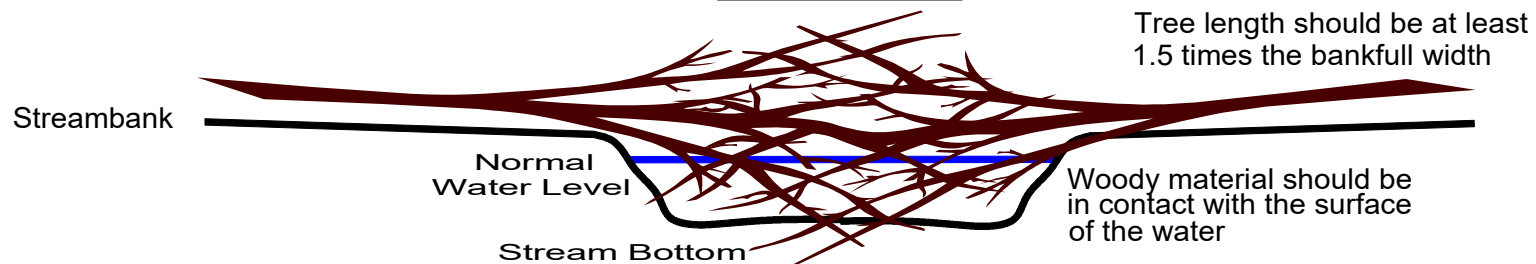

Trees = minimum 10" dia.

DHM, PFBC 2022



BANK COVER CRIBBING WITH ROOTWADS

Plan View

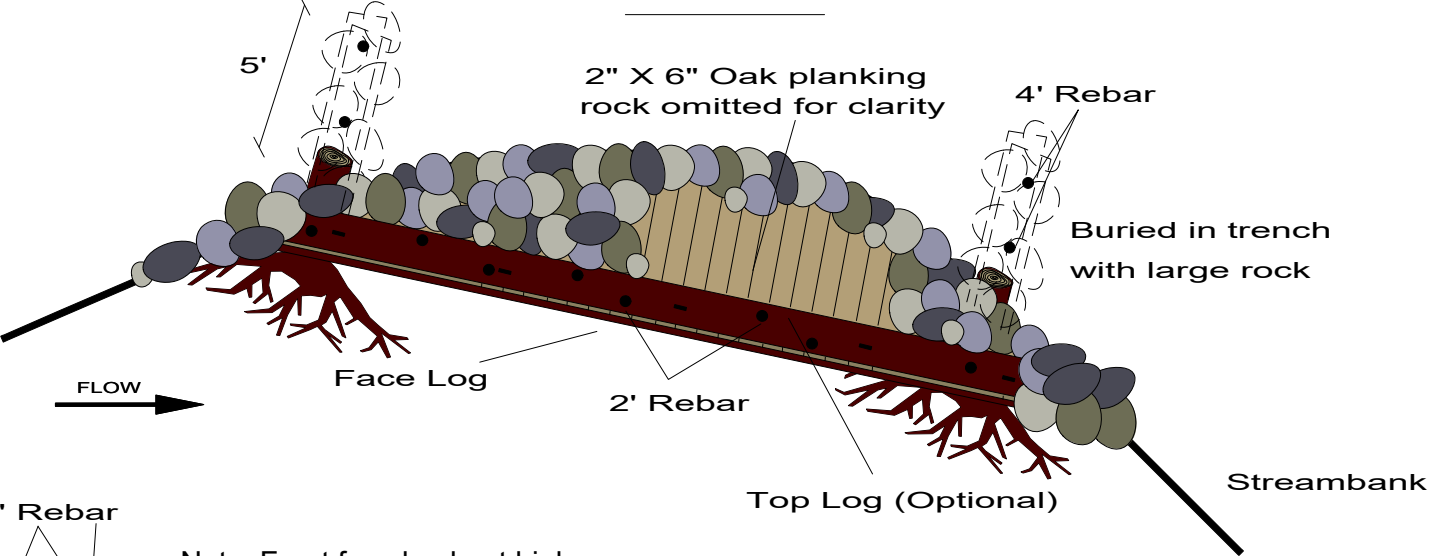

Section View

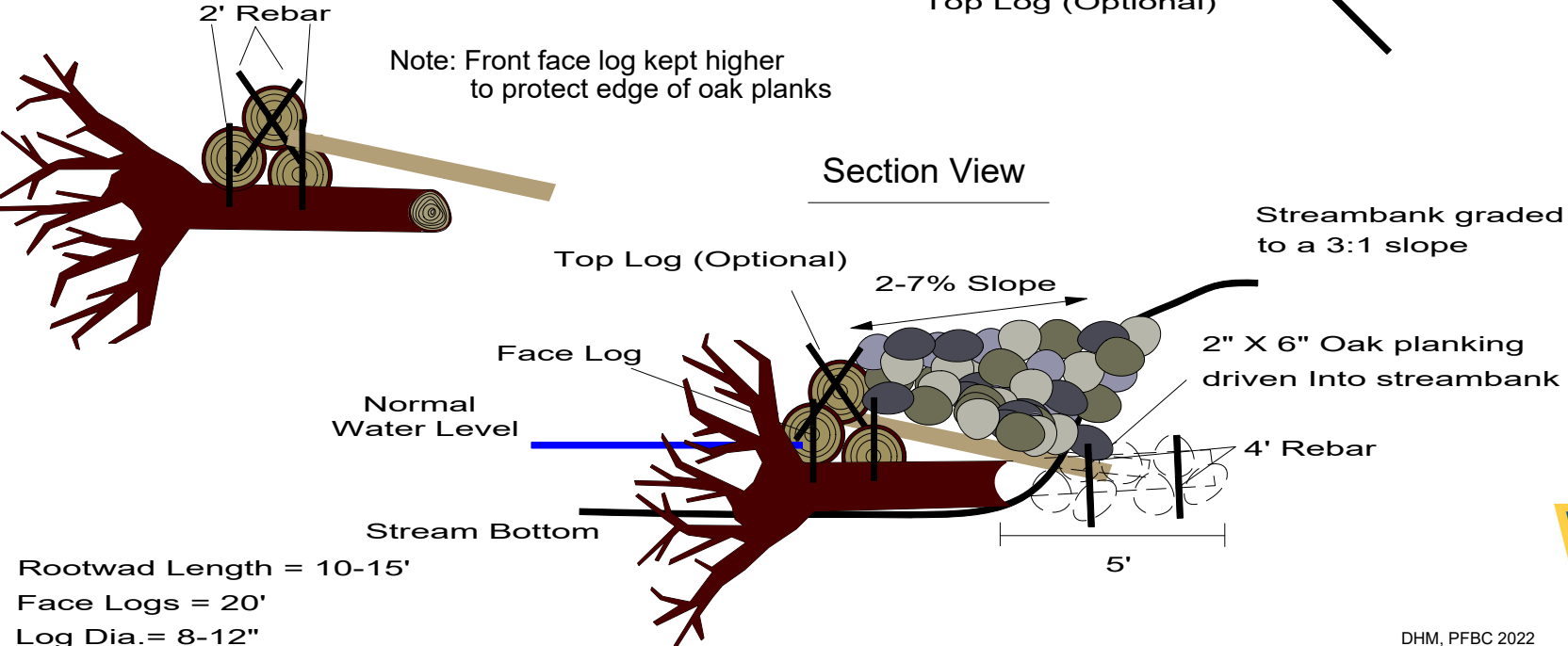

Rootwad Length = 10-15'
 Face Logs = 20'
 Log Dia. = 8-12"



BANK COVER CRIBBING

Plan View

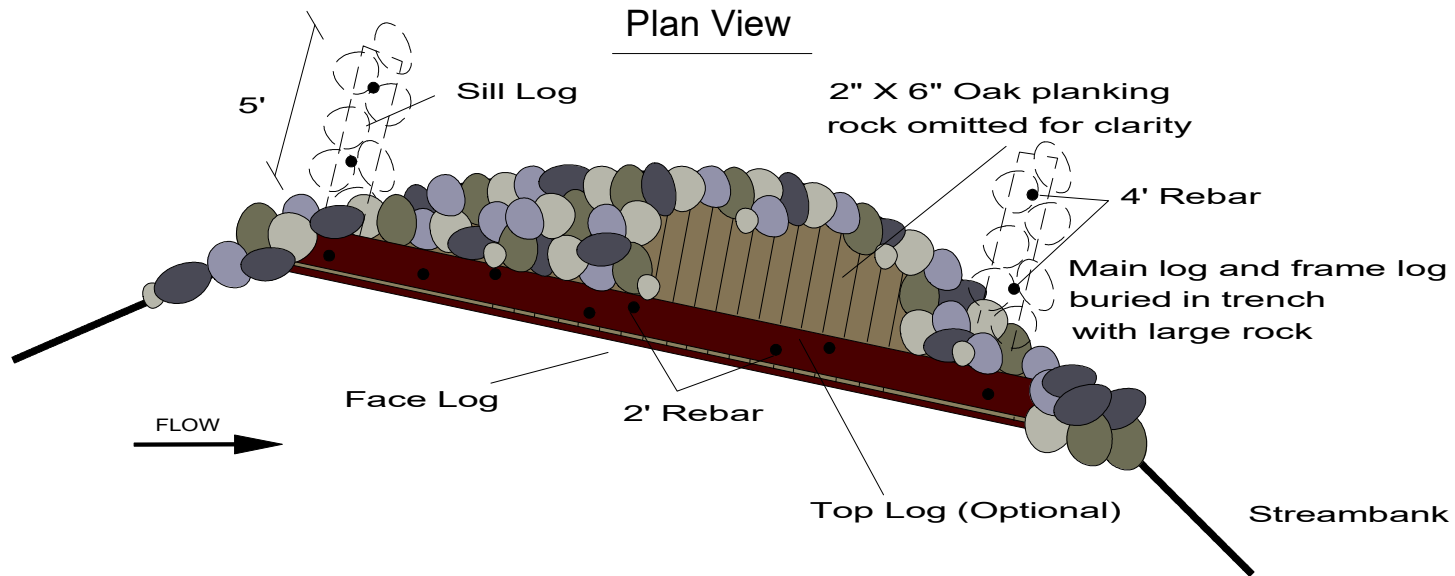

2' Rebar

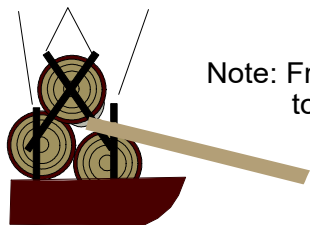

Note: Front face log kept higher
to protect edge of oak planks

Section View

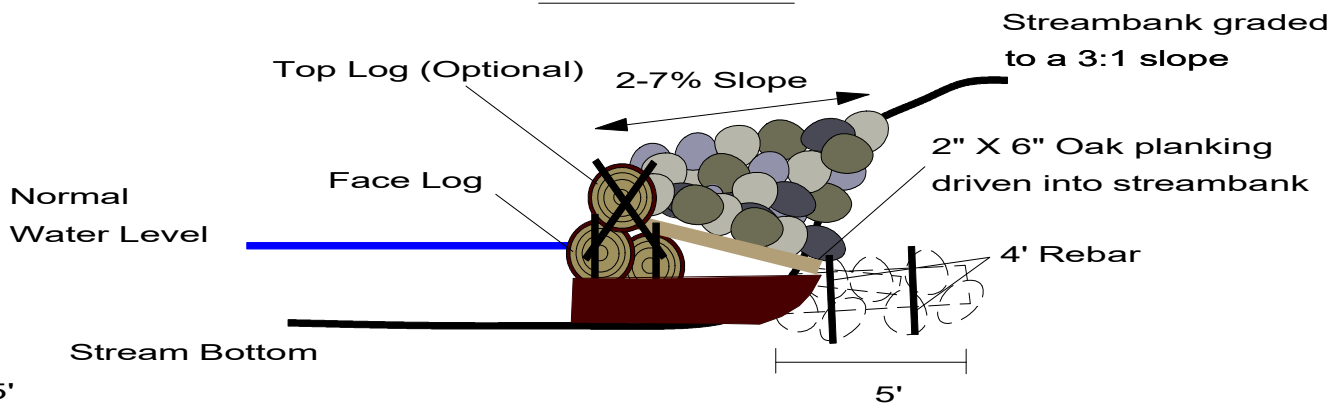

Sill Logs = 10-15'

Face Logs = 20'

Log Dia. = 8-12"



BRUSH REVETMENT

Plan View

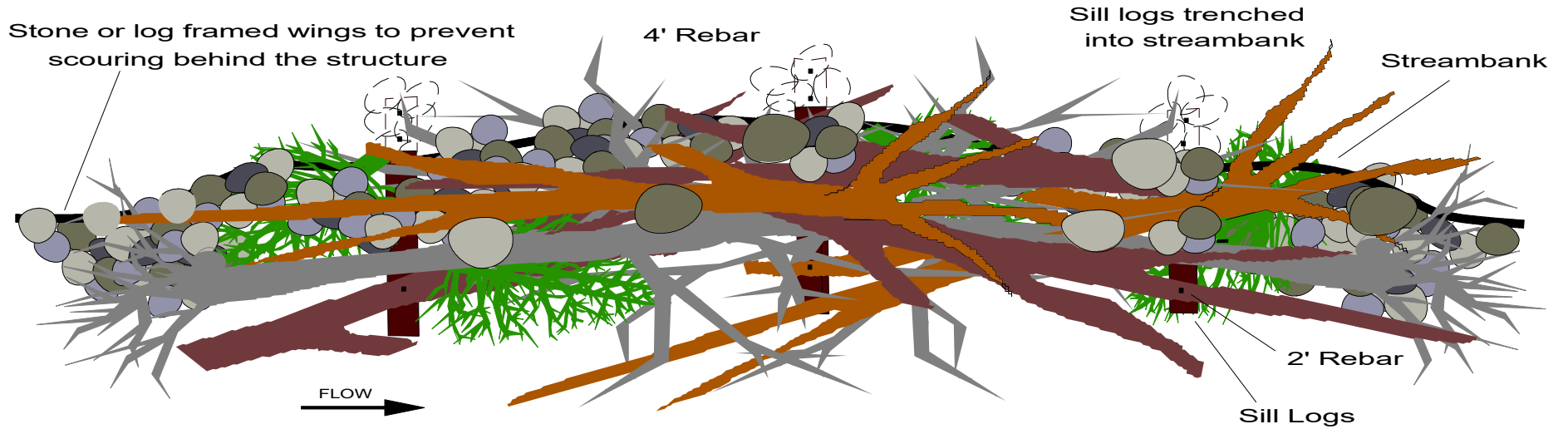

Note: Sill logs should be placed every 15-20 ft and attached to other trees using rebar if necessary
Stone can be added on top of the brush/trees for structural integrity/ballast

Section View

Note: 2' or 4' rebar connecting brush/trees together to the sill logs

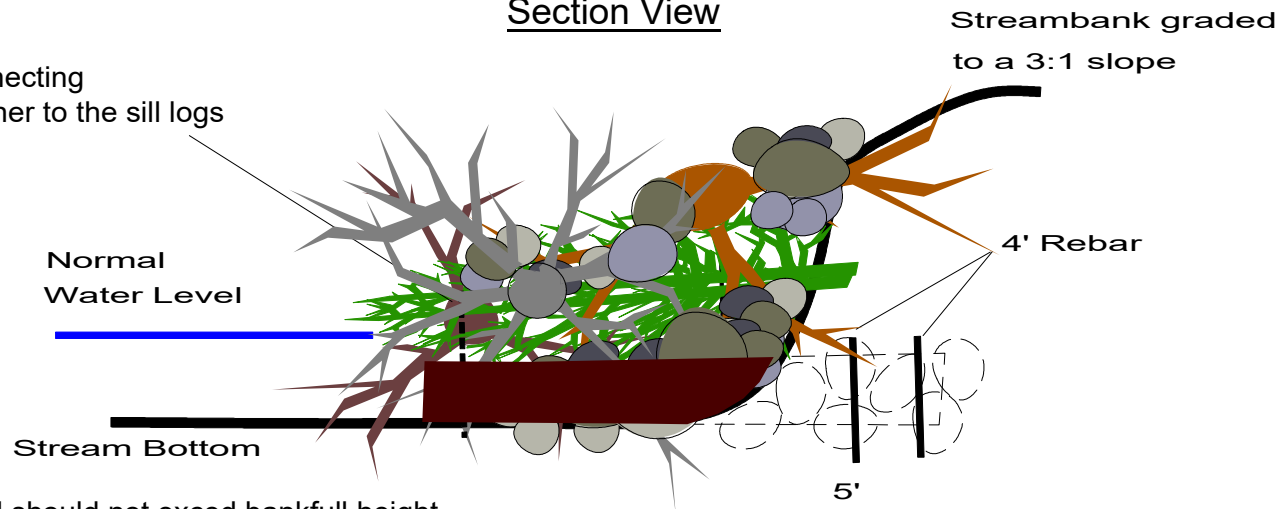

Note: Structure material should not exceed bankfull height

DHM, PFBC 2022



MODIFIED MUD SILL CRIBBING WITH ROOTWADS

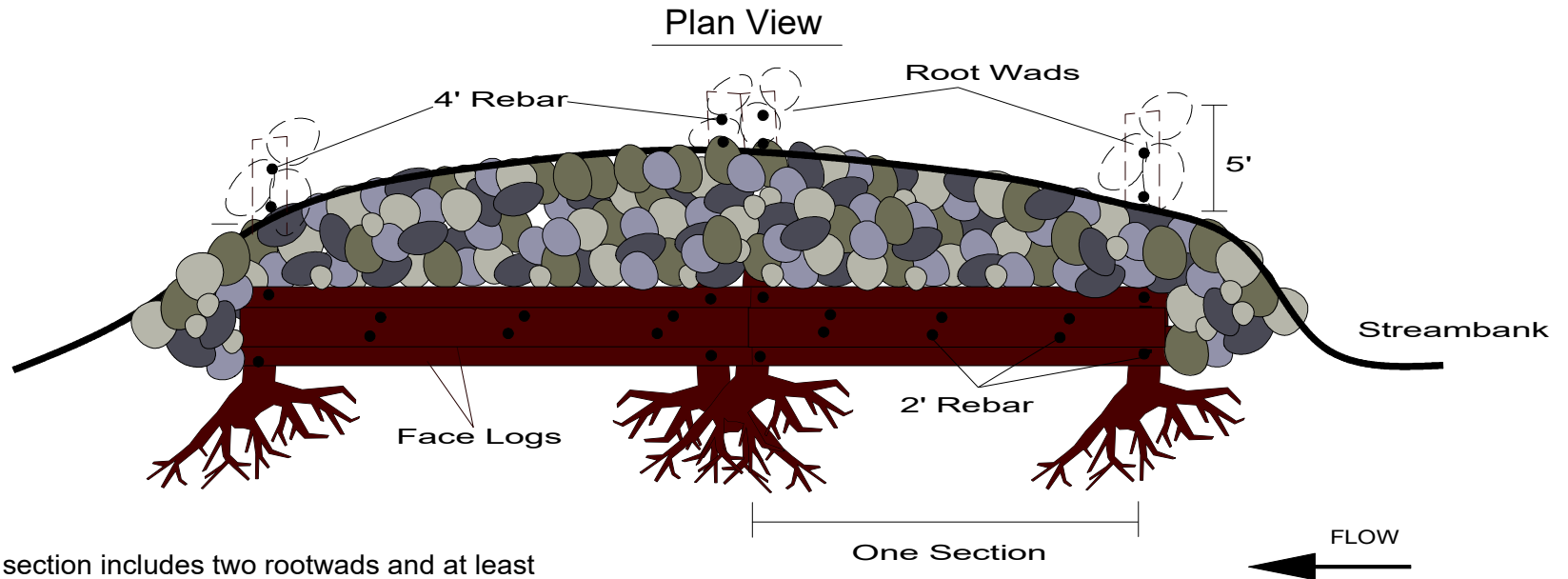

Note: Each section includes two rootwads and at least two face logs, sections can be added or removed

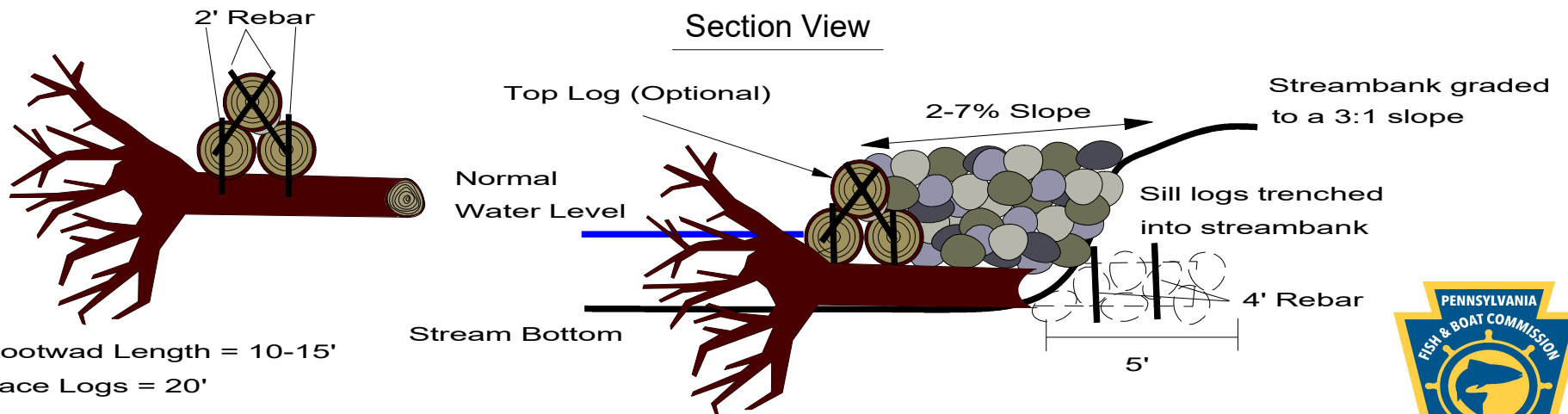

Rootwad Length = 10-15'
 Face Logs = 20'
 Log Dia. = 8-12"

DHM, PFBC 2022



MODIFIED MUD SILL CRIBBING

Plan View

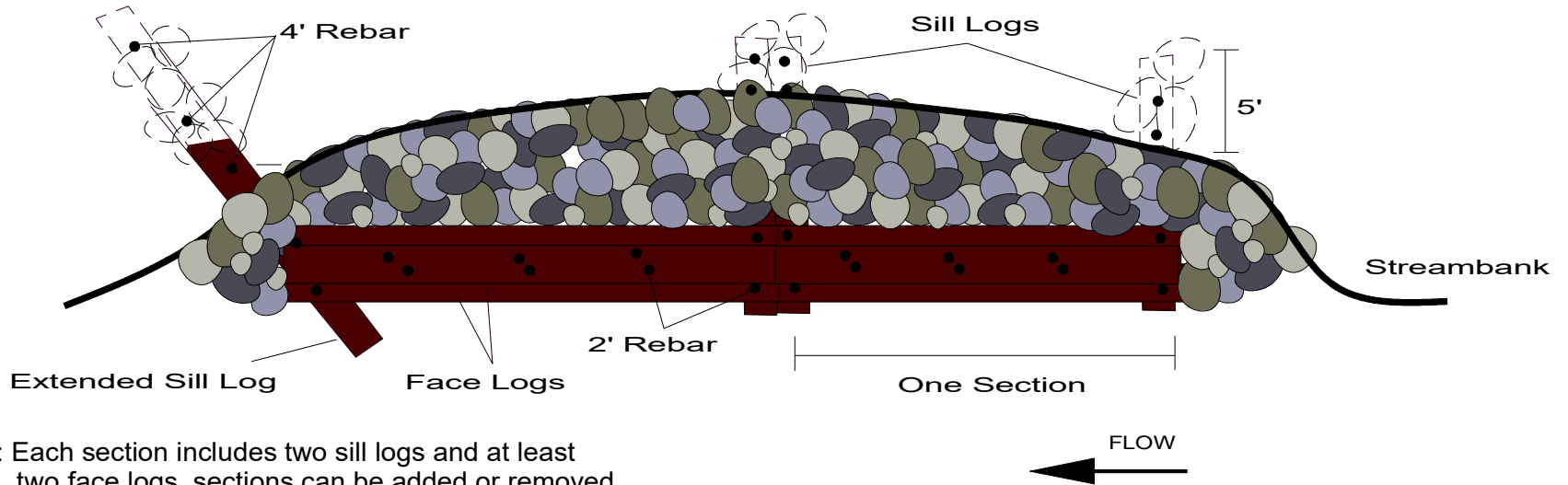

Note: Each section includes two sill logs and at least two face logs, sections can be added or removed

Note: Ending section can have extended sill log

Section View

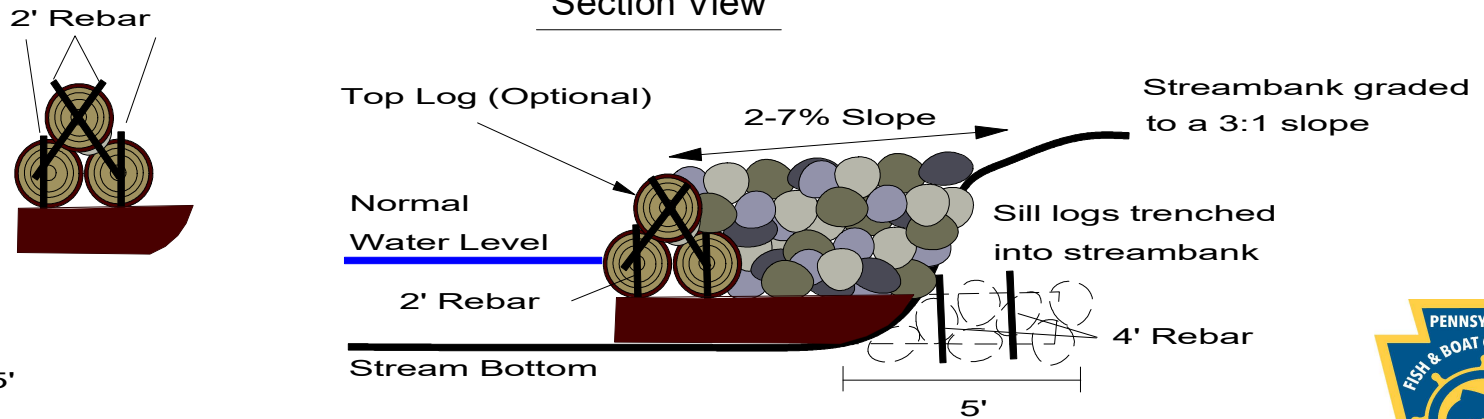

Sill Logs = 10-15'
 Face Logs = 20'
 Log Dia. = 8-12"



MUD SILL CRIBBING

Plan View

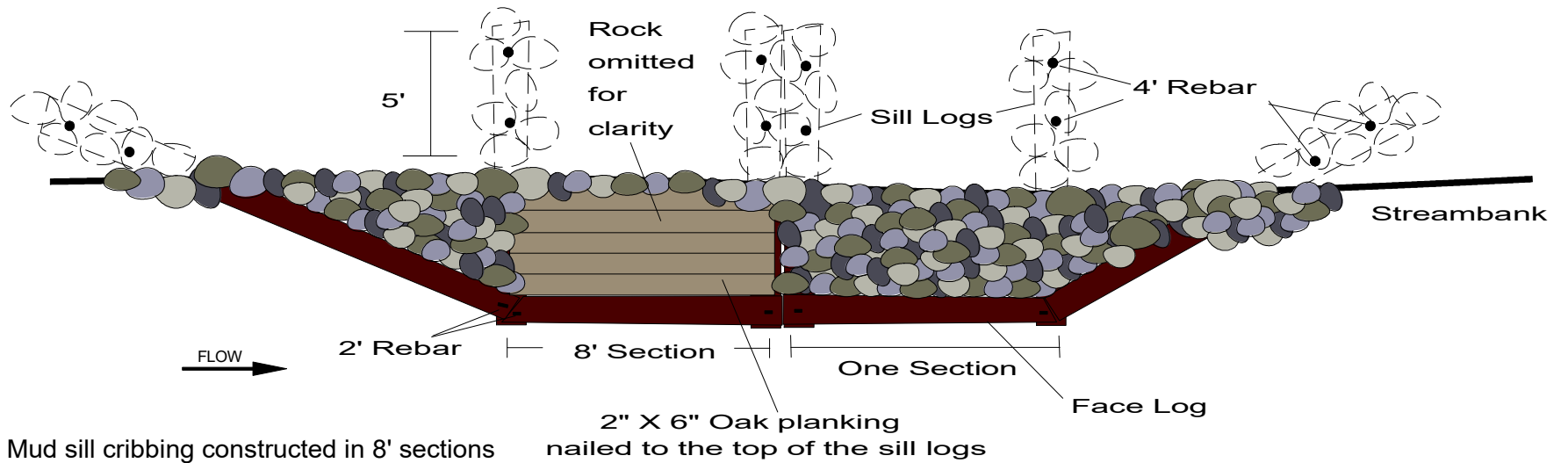

Note: Mud sill cribbing constructed in 8' sections
Sections can be added or removed

Section View

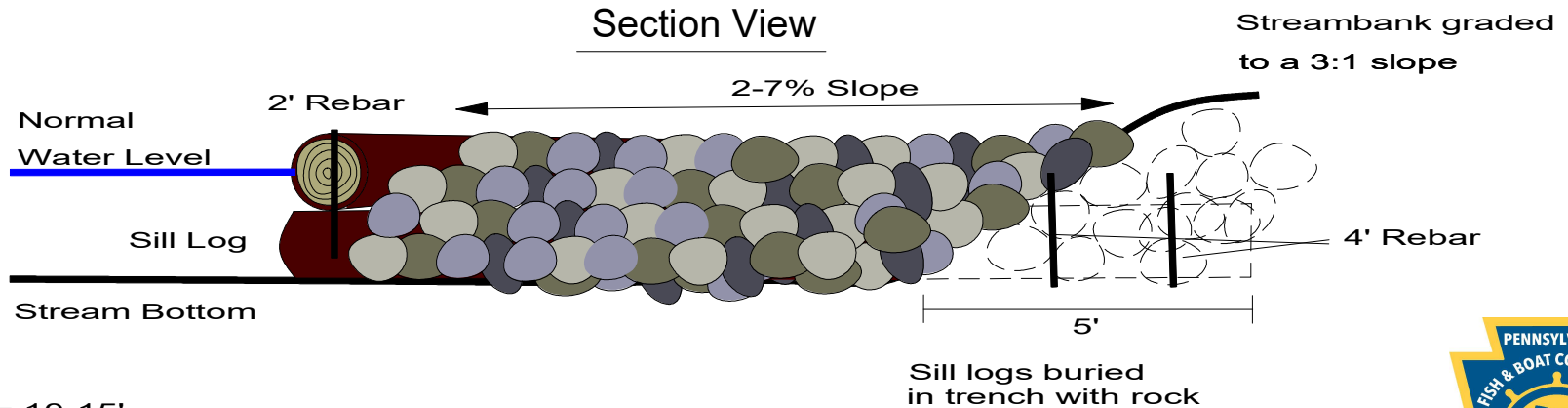

Sill Logs = 10-15'
Face Logs = 8'
Log Dia. = 8-12"

DHM, PFBC 2022



SAWTOOTH MODIFIED MUDSILL CRIBBING

Plan View

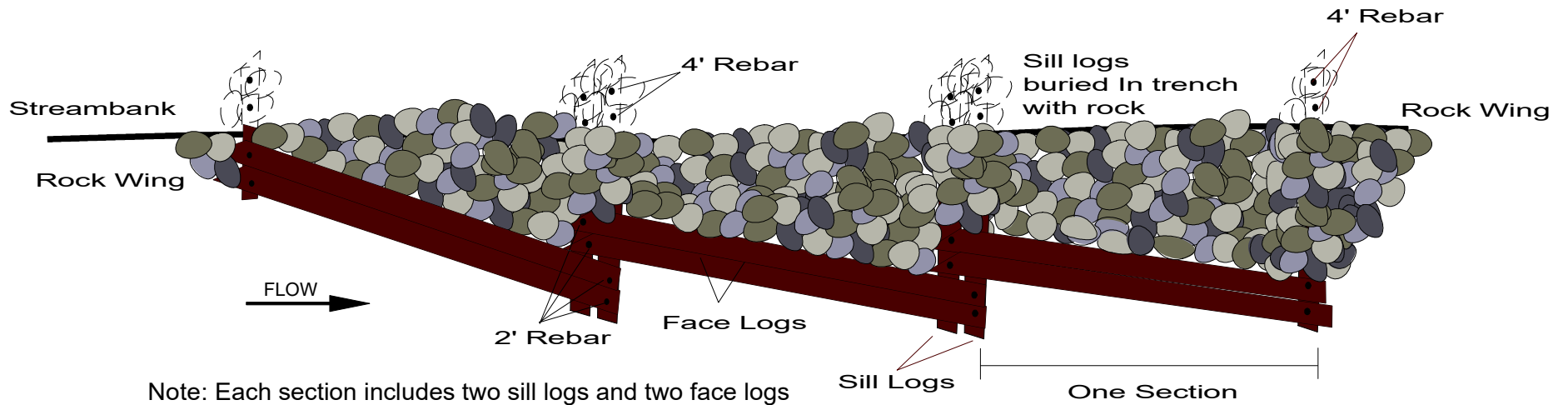

Note: Each section includes two sill logs and two face logs
Sections can be added or removed

Section View

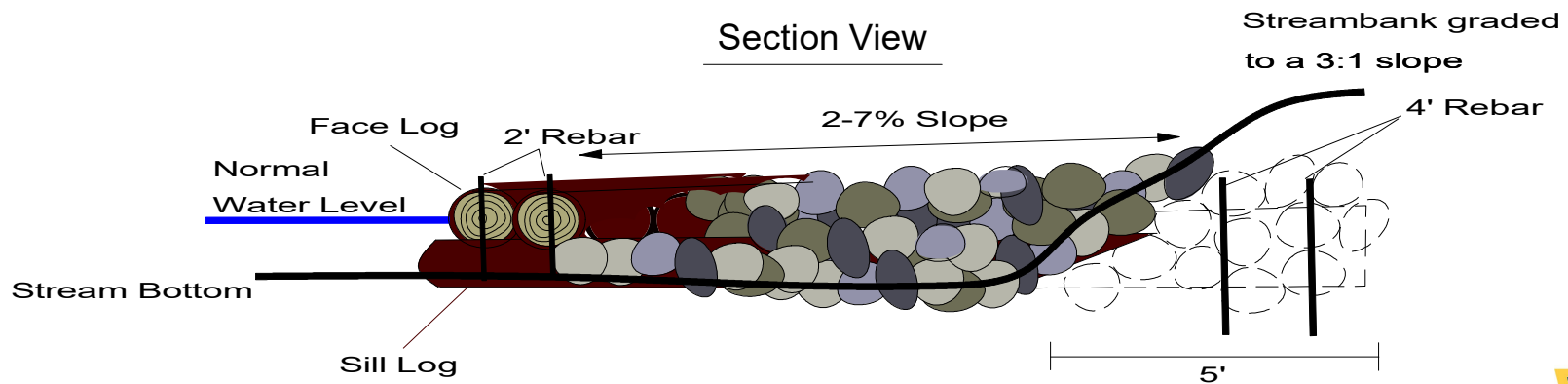

Sill Logs = 10-15'
Face Logs = 20'
Log Dia. = 8-12"



TOE LOG CRIBBING

(LOW GRADIENT STRUCTURE)

Plan View

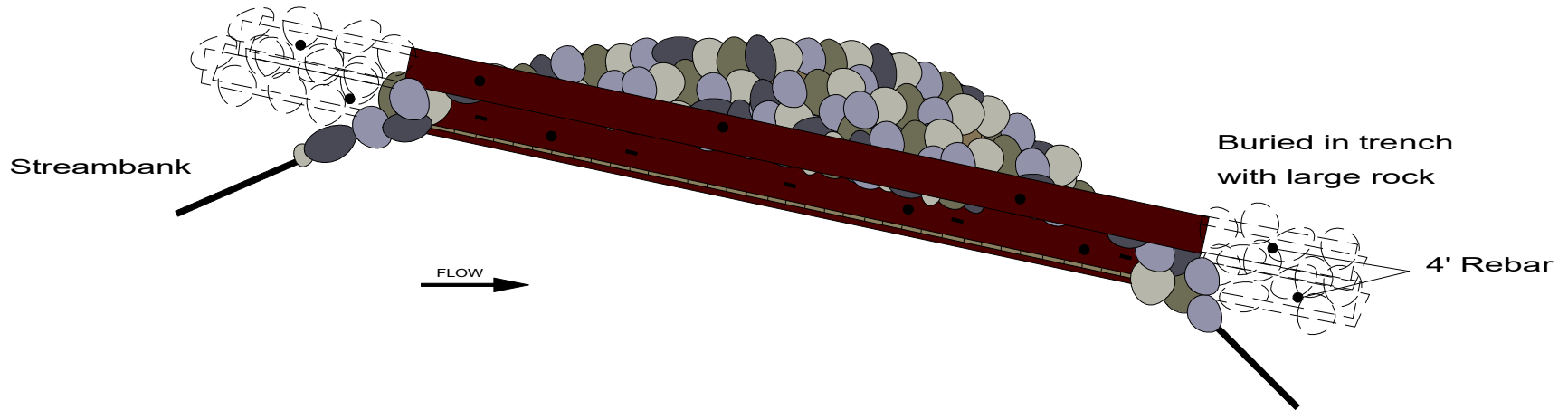

Section View

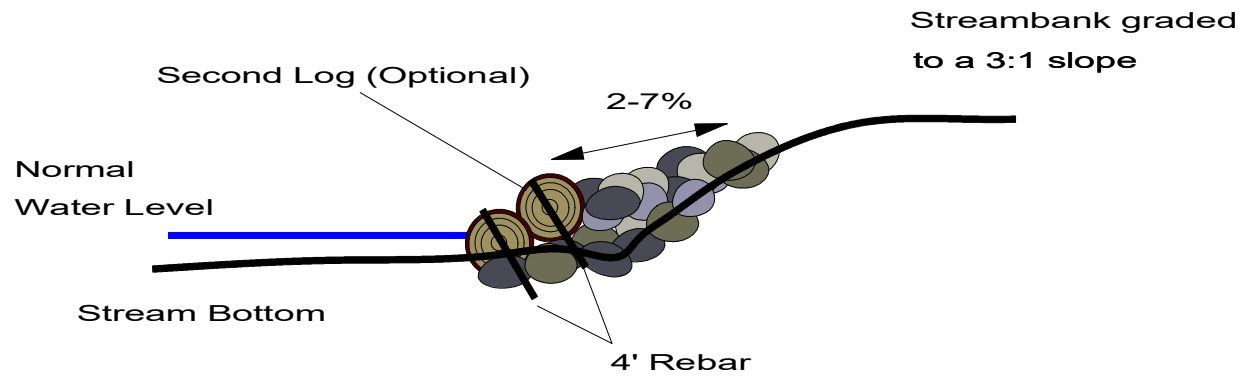

Log Dia.= 8-12"

Note: Recommended only for use in low gradient systems

DHM, PFBC 2022



CROSS LOG VANE

(LOW GRADIENT STRUCTURE)

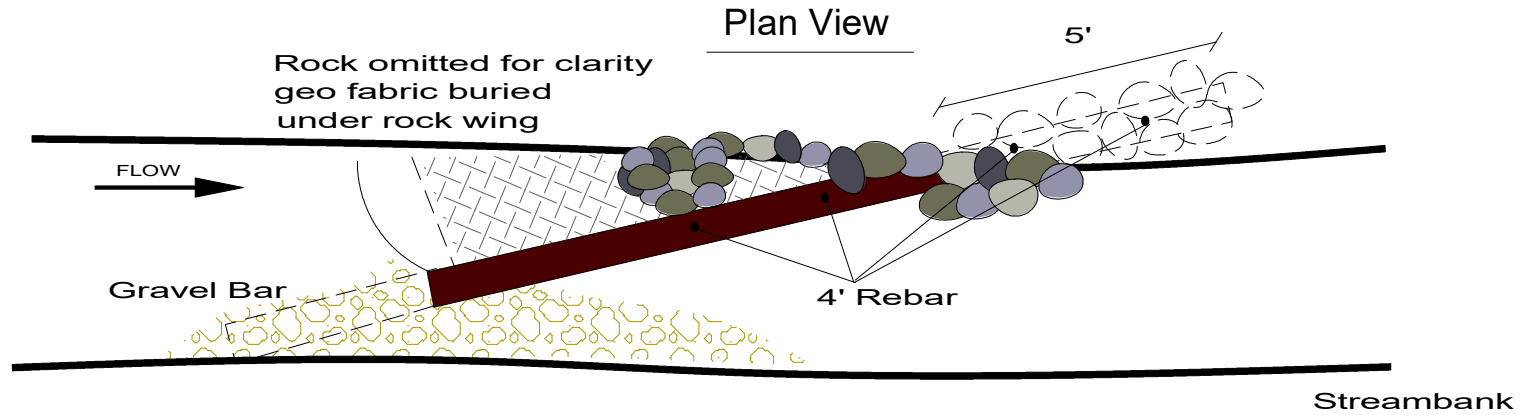

4' Rebar Pin

Section View

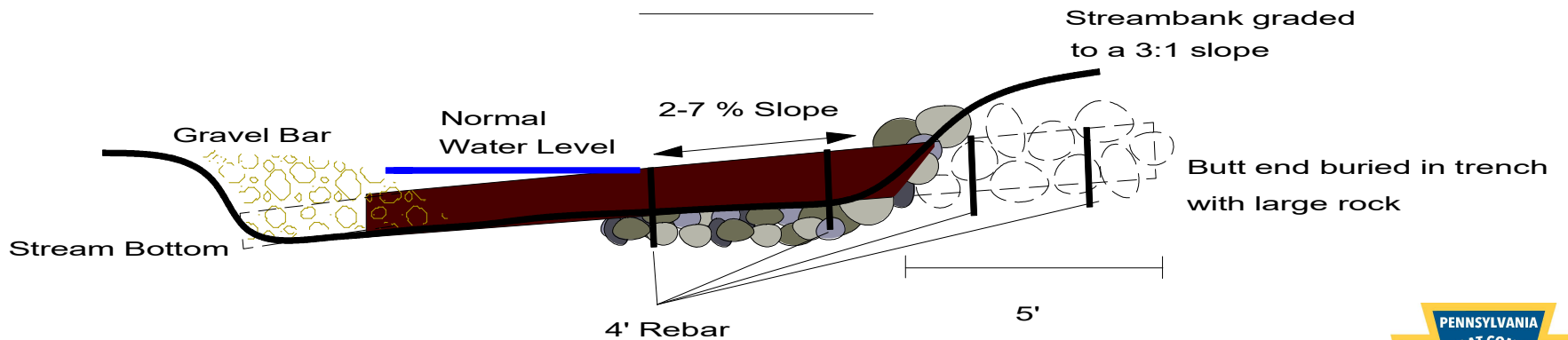

Log Length = 15-25'

Log Dia. = 8-12"

Note: Low gradient structure designed to prevent gravel bar growth

DHM, PFBC 2022



LOG CROSS VANE WITH ROCK THROAT

Plan View

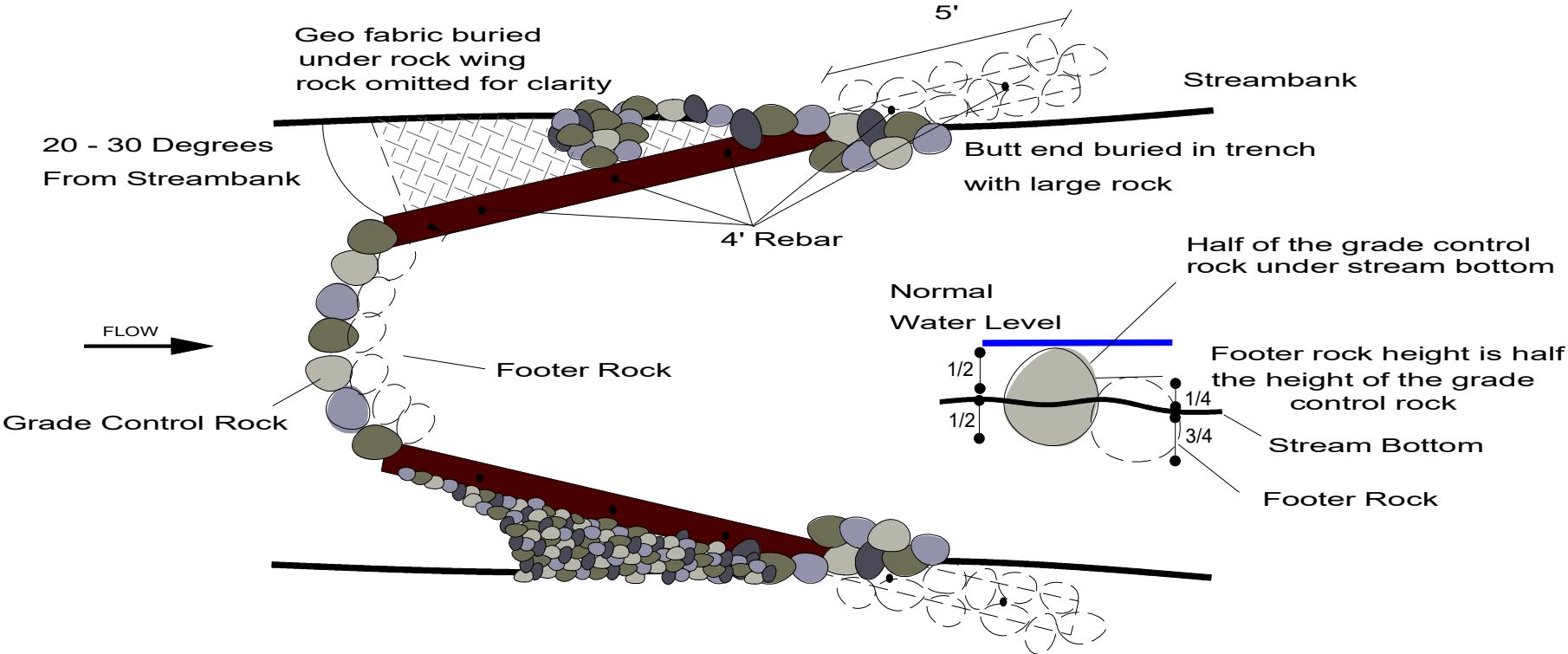

Section View

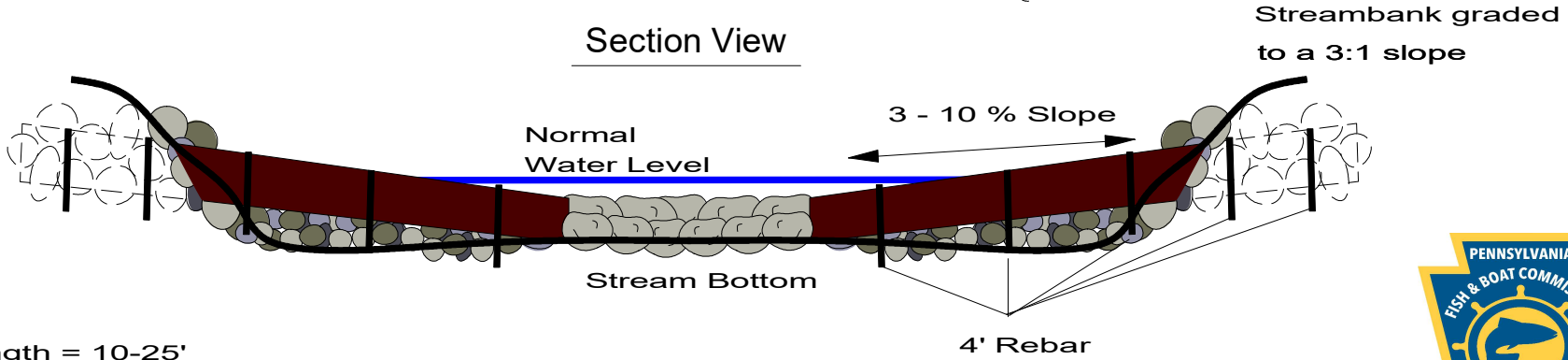

Log Length = 10-25'
Log Dia. = 8-12"



LOG CROSS VANE (LOW GRADIENT STRUCTURE)

Plan View

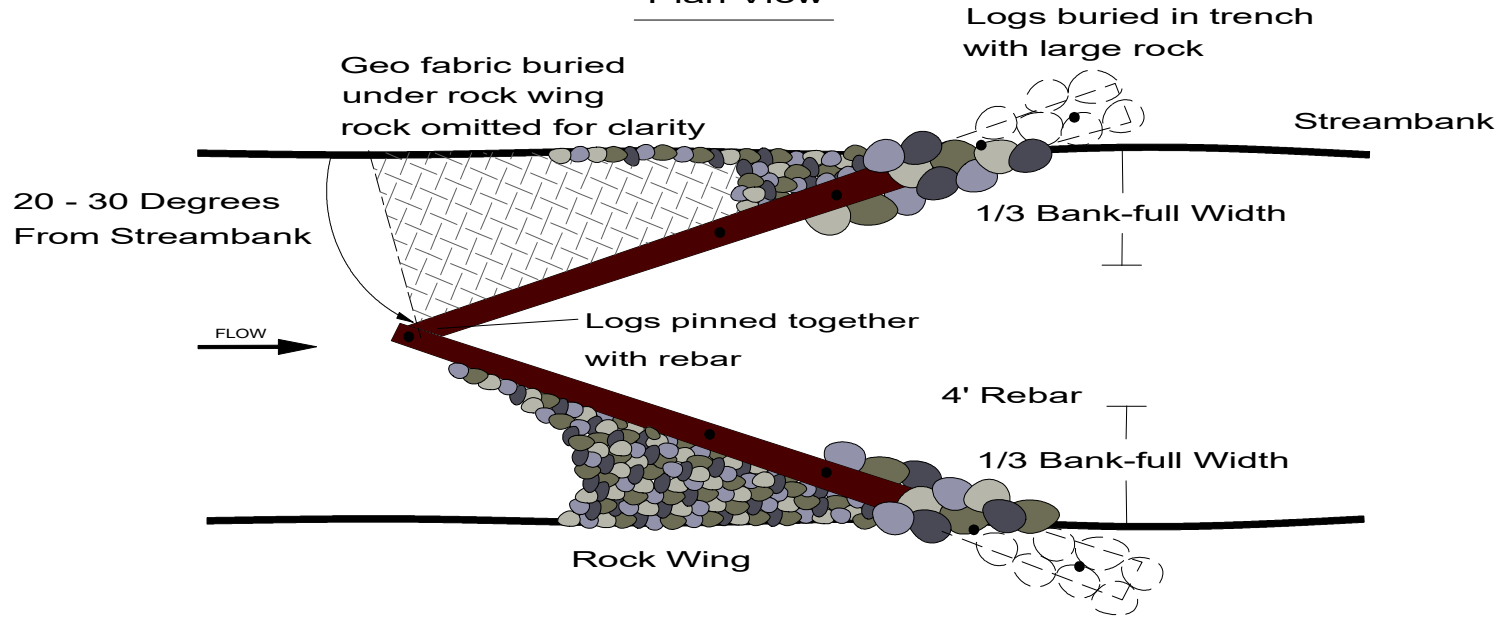

Section View

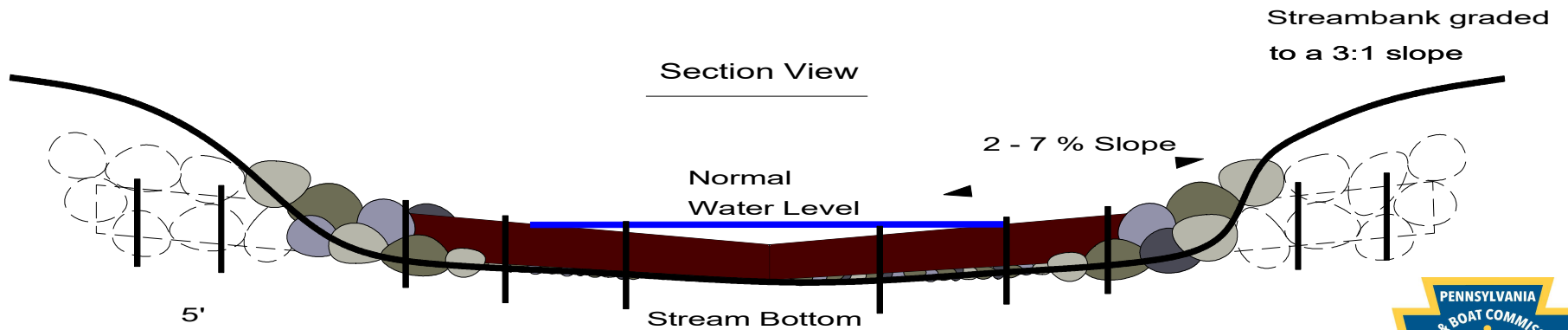

Log Length = 10-25'

Log Dia. = 8-12"

Note: Recommended only for use in low gradient systems

4' Rebar



LOG FRAMED CROSS VANE WITH ROCK THROAT

Plan View

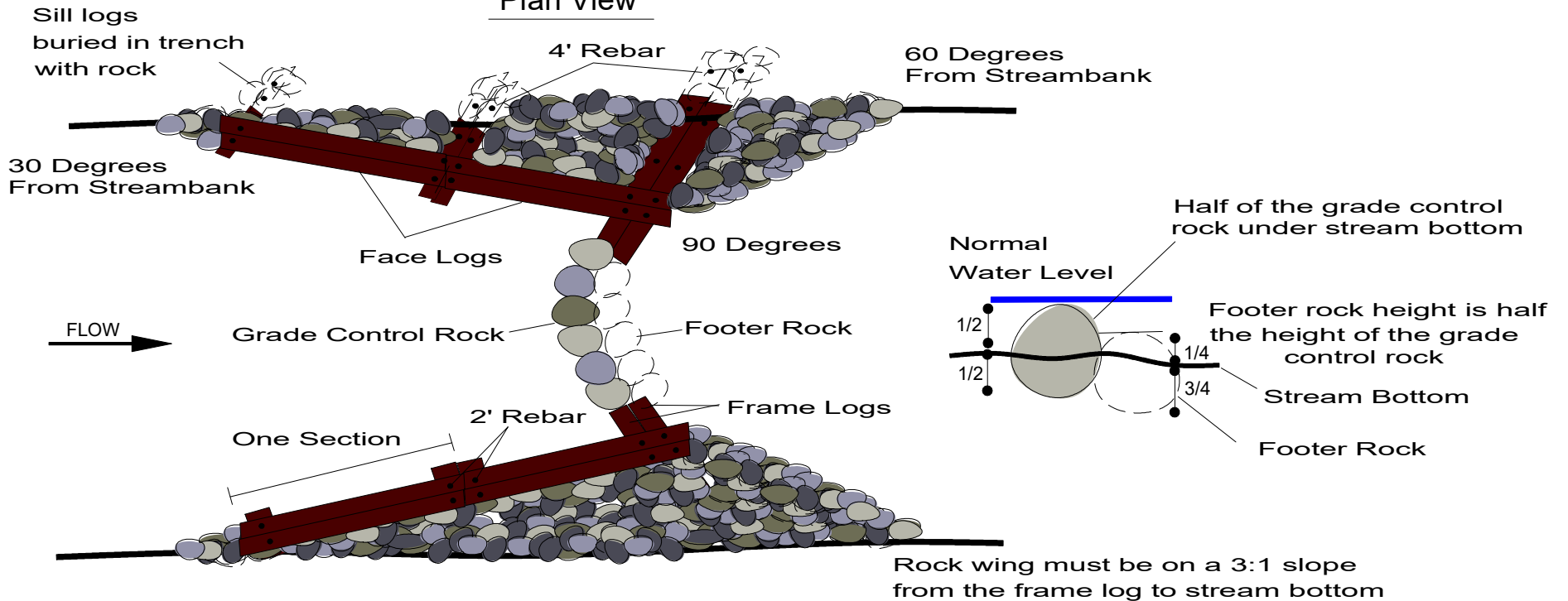

Note: Sections can be added or removed

Section View

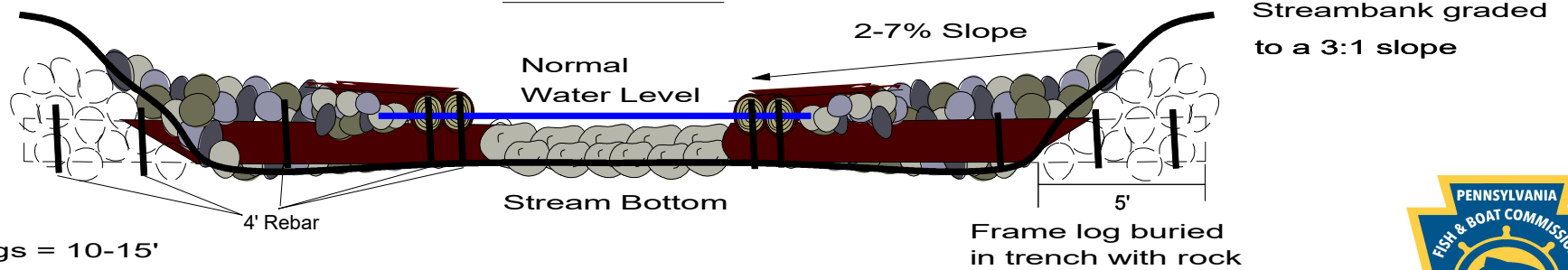

Sill Logs = 10-15'
 Face Logs = 20'
 Frame Logs = 20-30'
 Log Dia. = 8-12"

DHM, PFBC 2022



LOG FRAMED CROSS VANE

Profile View

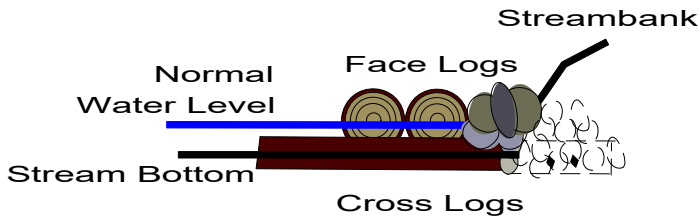

Note: Upstream wings can be log or stone
 Note: Additional upstream or downstream wing sections can be added

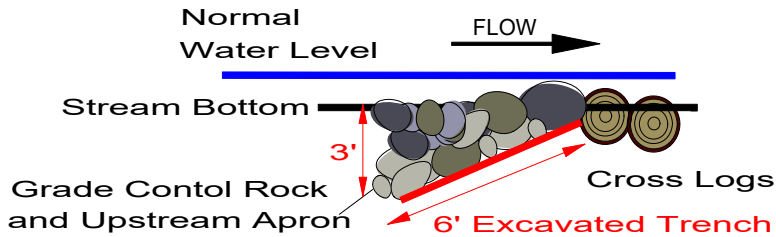

Note: Excavated trench in stream bottom
 3' deep x 6' sloped x width of the stream

Plan View

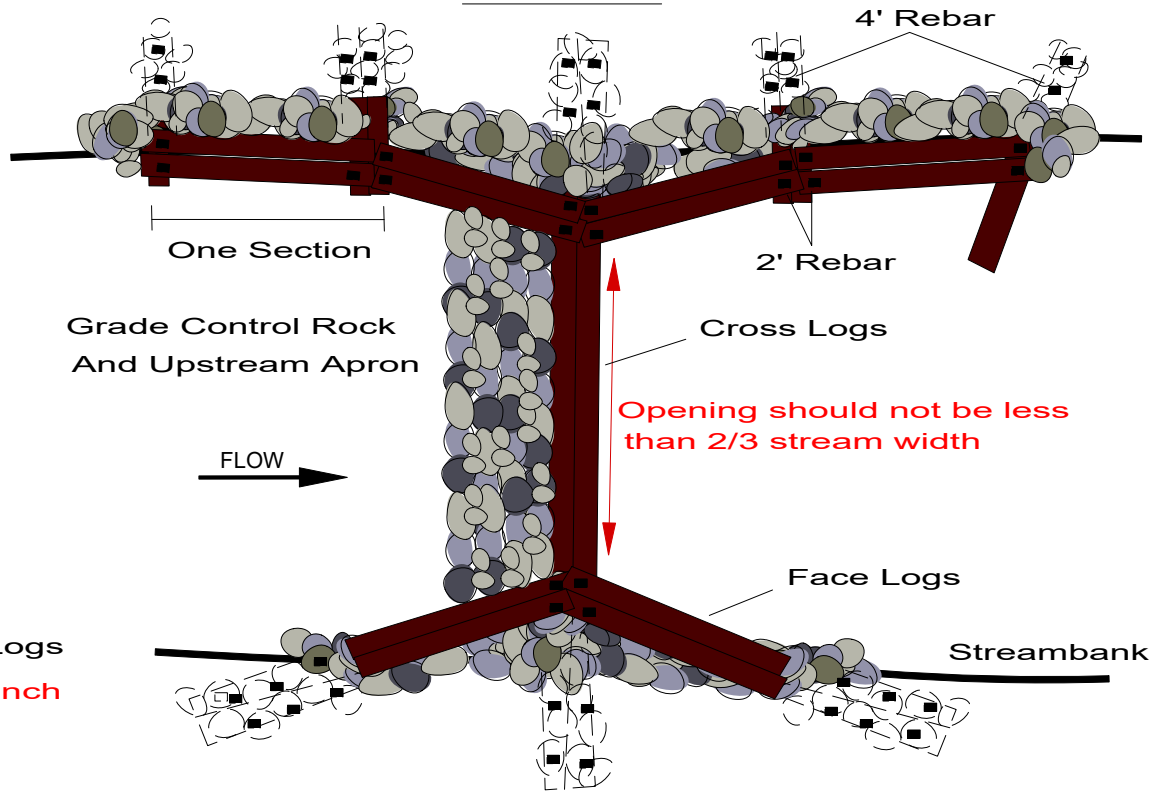

Section View

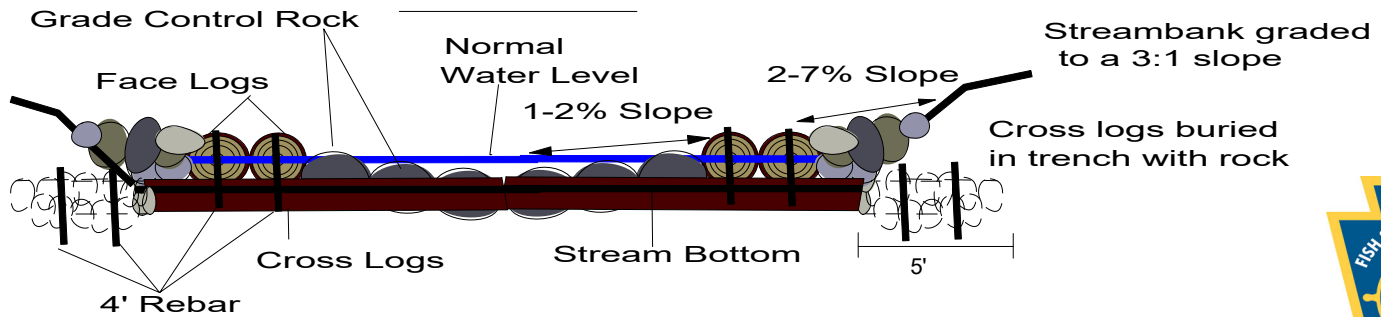

Sill Logs = 10-15'
 Face Logs = 20'
 Cross Logs = 10-30'
 Log Dia. = 8-12"



LOG FRAMED CROSS VANE WITH WING EXTENSIONS

Profile View

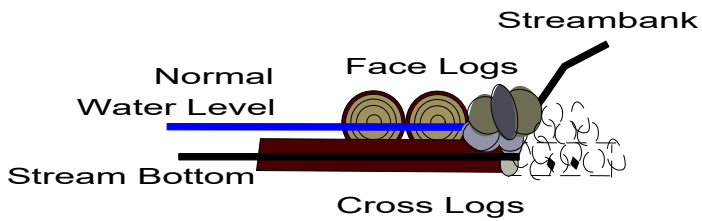

Note: Upstream wings can be log or stone
 Note: Additional upstream or downstream wing sections can be added

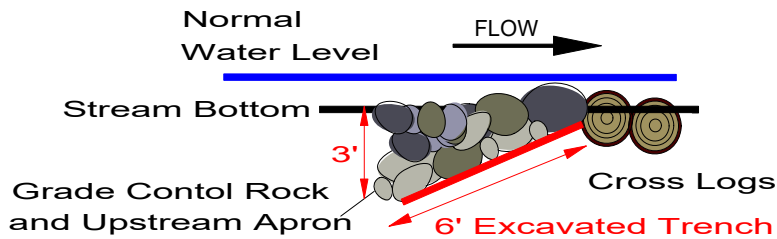

Note: Excavated trench in stream bottom
 3' deep x 6' sloped x width of the stream

Plan View

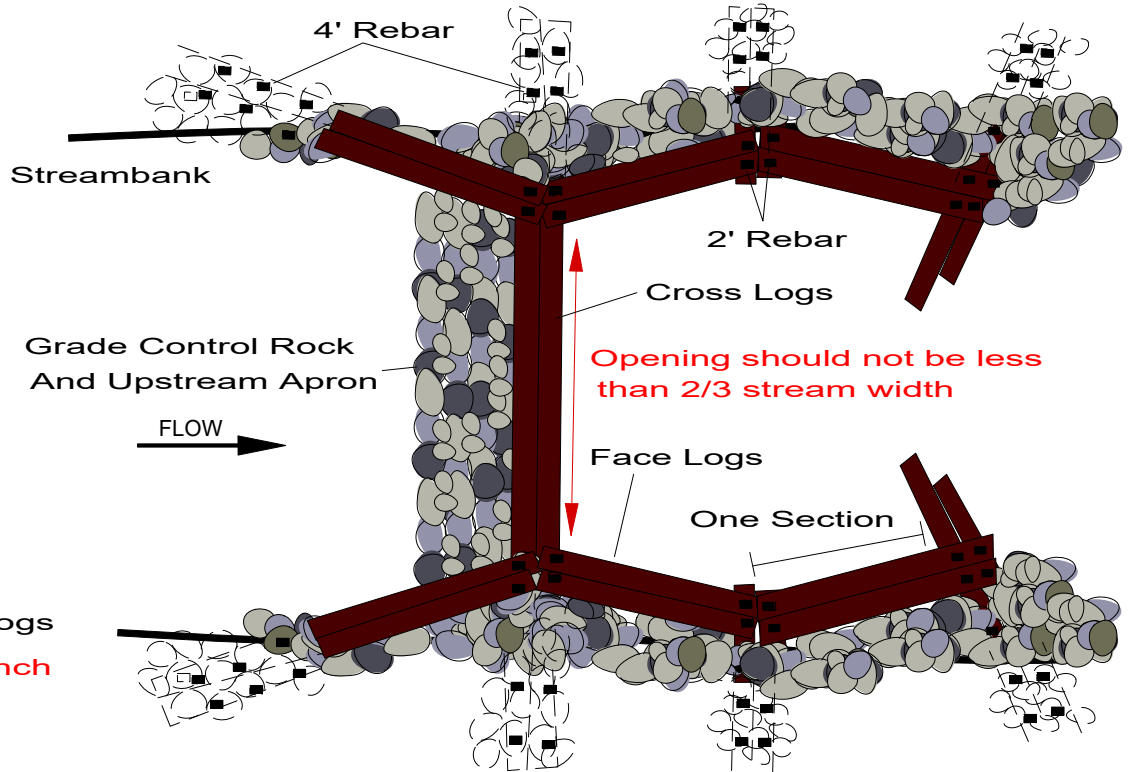

Section View

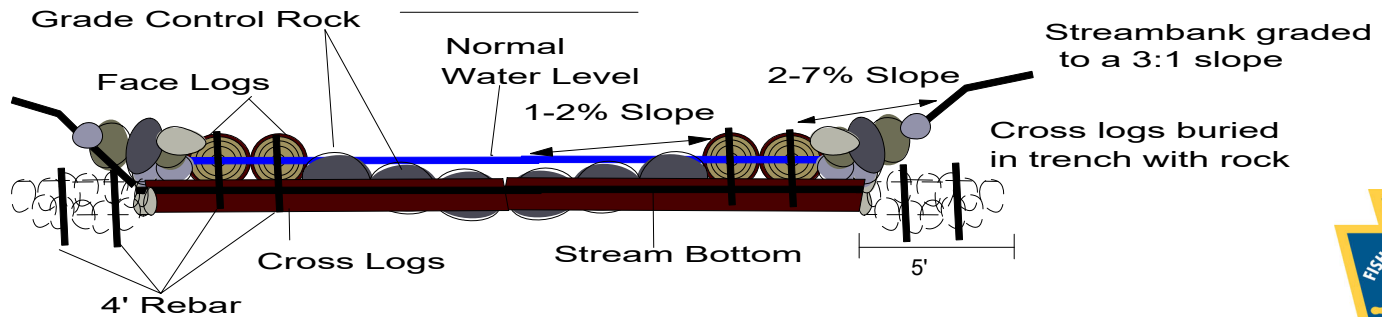

Sill Logs = 10-15'
 Face Logs = 20'
 Cross Logs = 10-30'
 Log Dia. = 8-12"



MULTI-LOG VANE DEFLECTOR WITH J-HOOK

Plan View

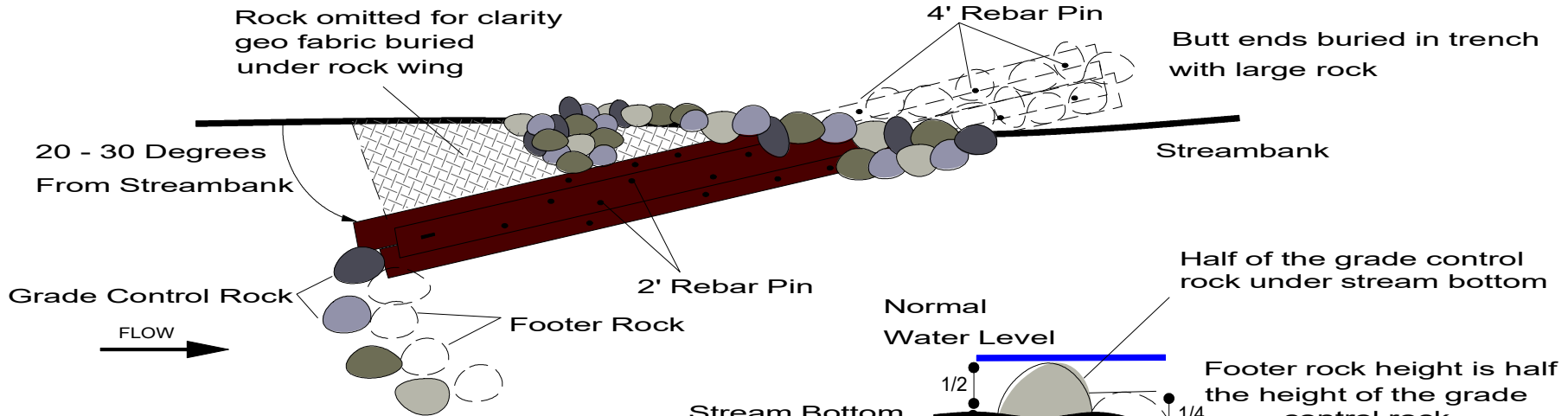

Section View

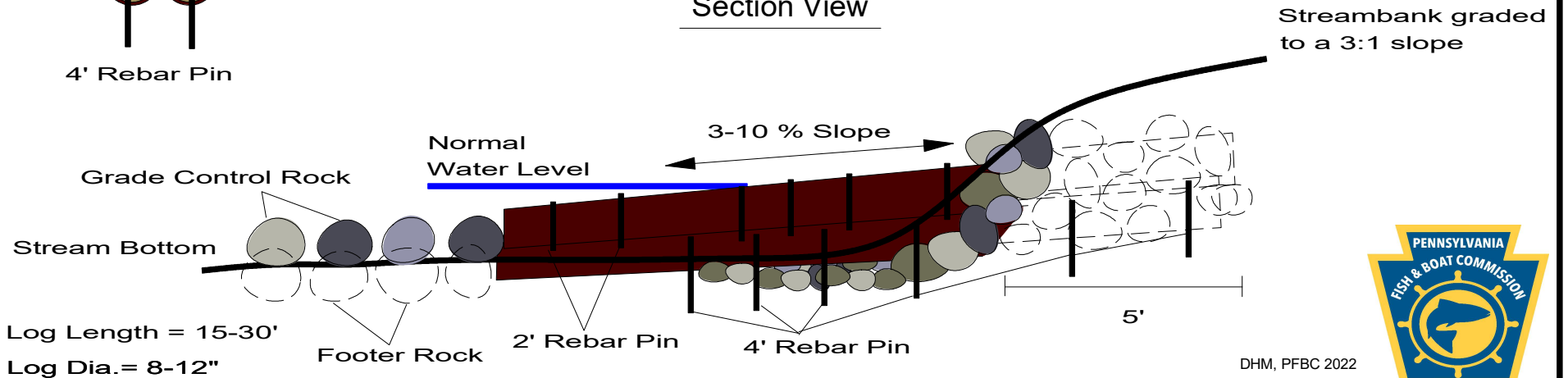

MULTI-LOG VANE DEFLECTOR

Plan View

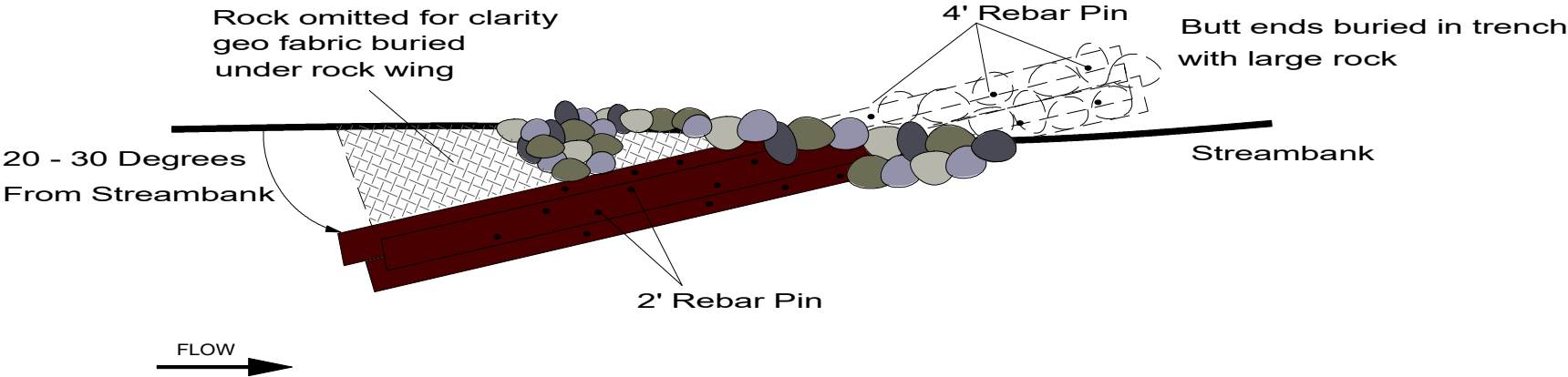

Section View

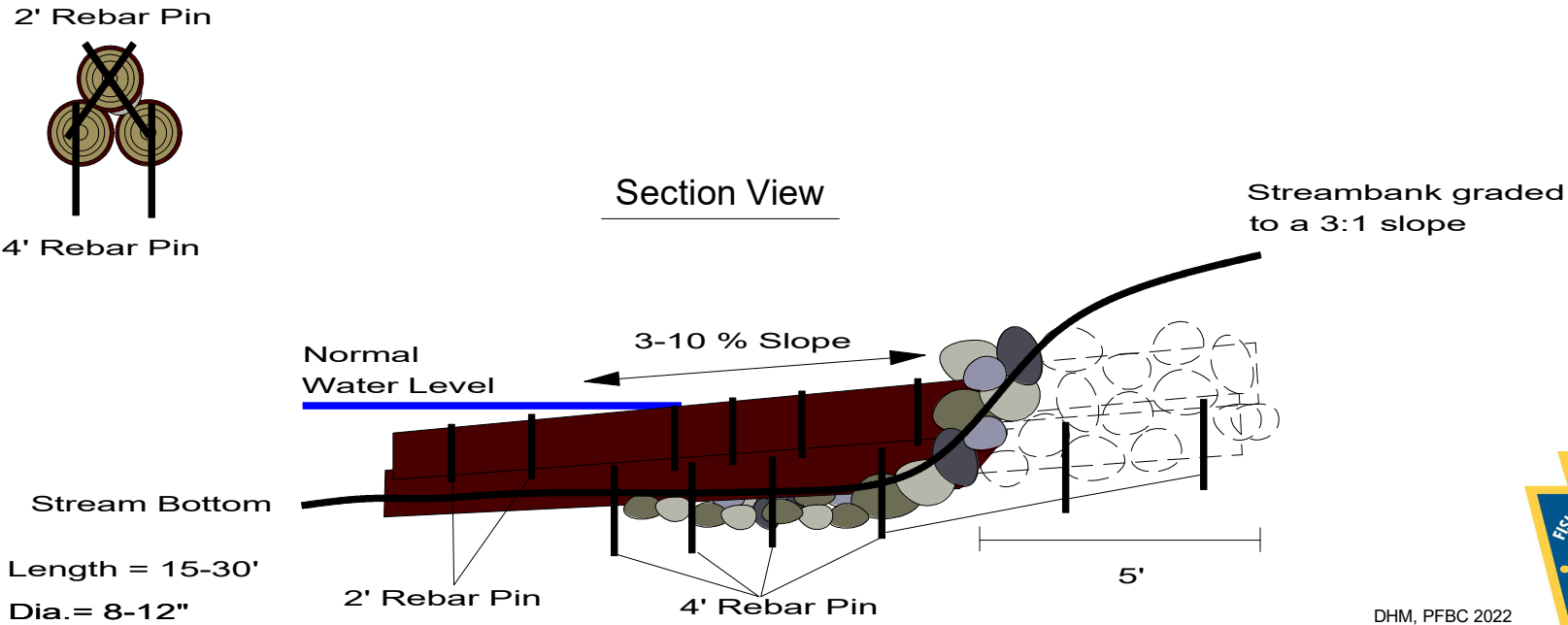

ROCK CROSS VANE

Plan View

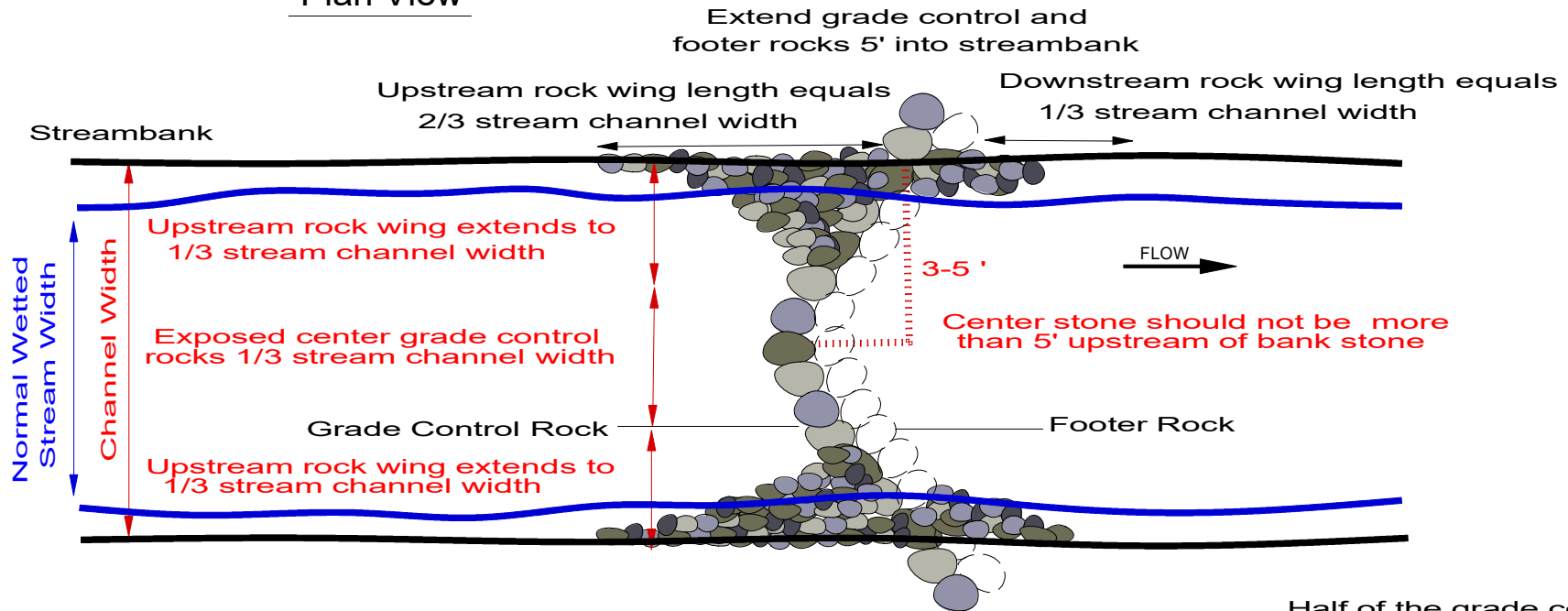

Streambank graded to a 3:1 slope

Section View

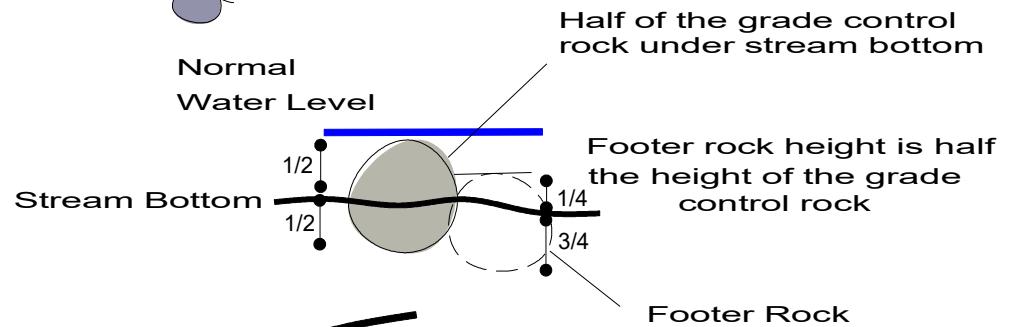
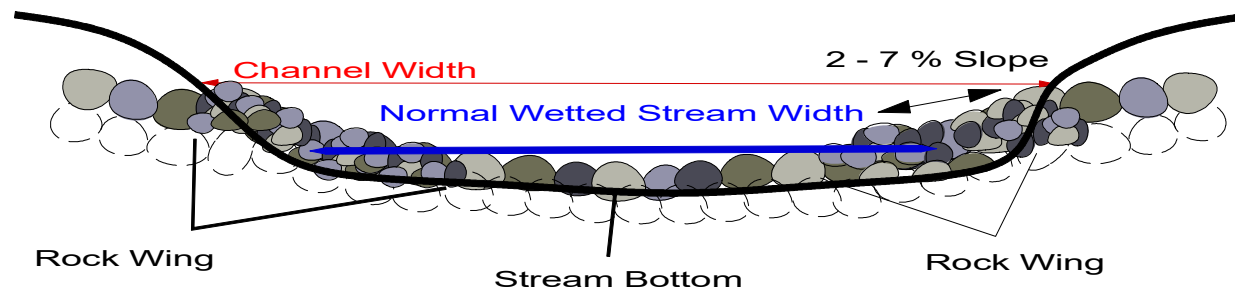

ROCK RIFFLE

(LOW GRADIENT STRUCTURE)

Plan View

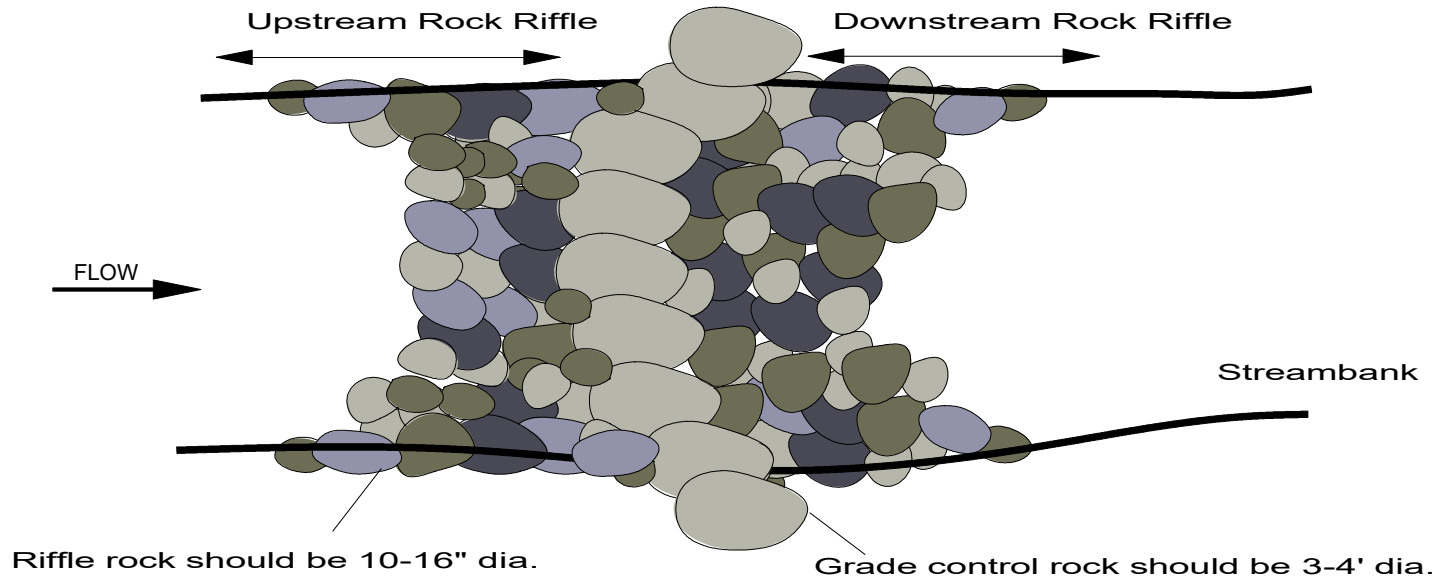

Section View

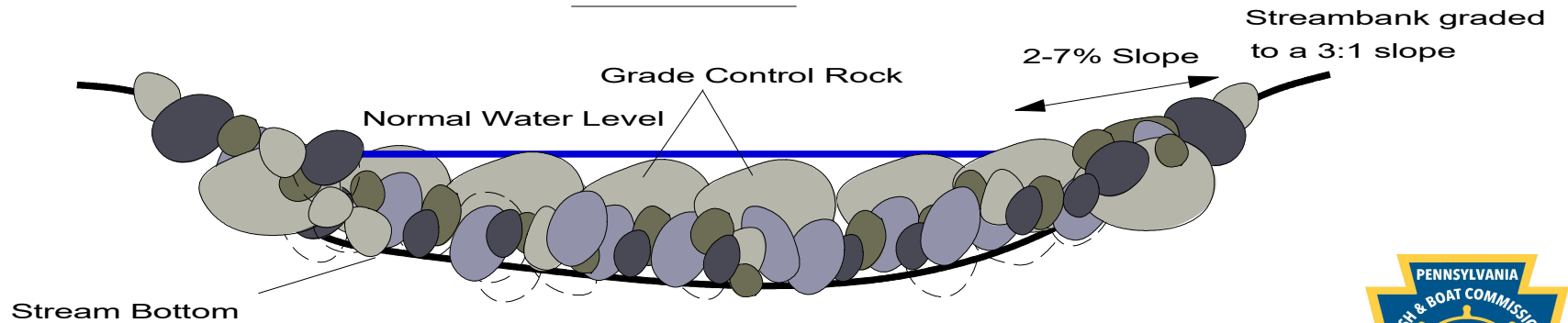

Note: Recommended only for use in low gradient systems

DHM, PFBC 2022



ROCK VANE DEFLECTOR

Plan View

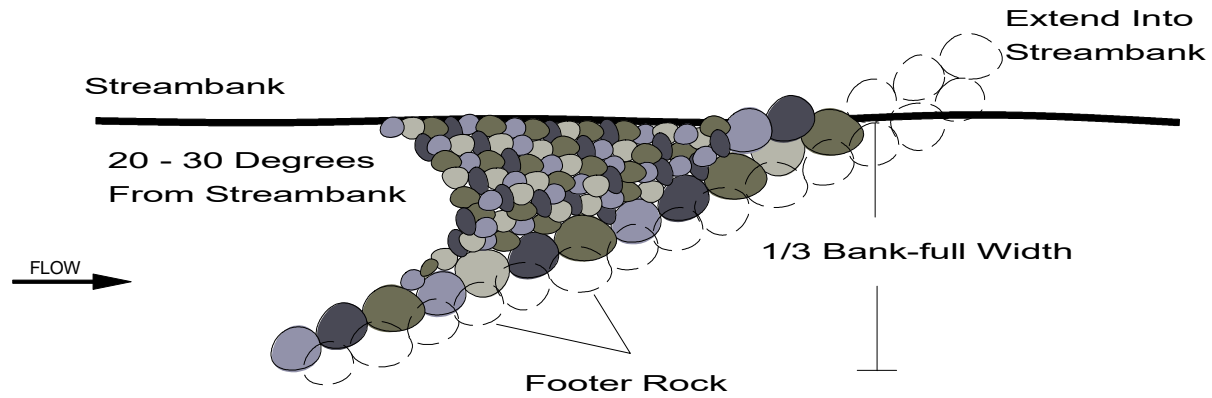

Section View

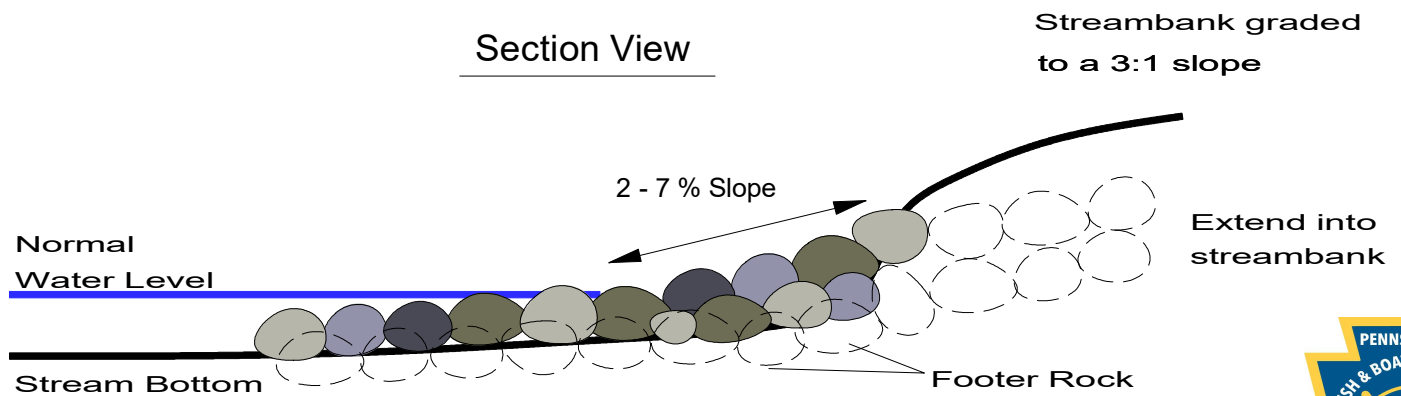

ROCK VANE DEFLECTOR WITH J-HOOK

Plan View

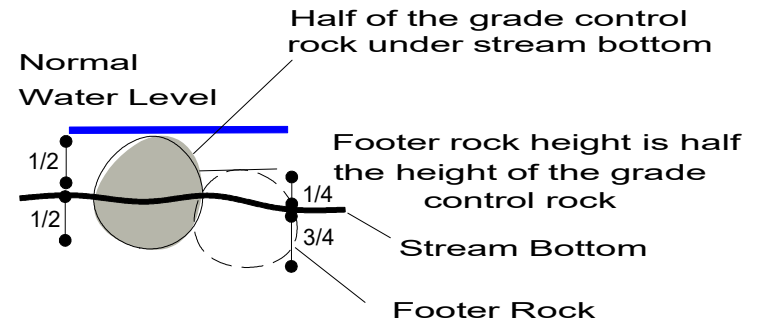
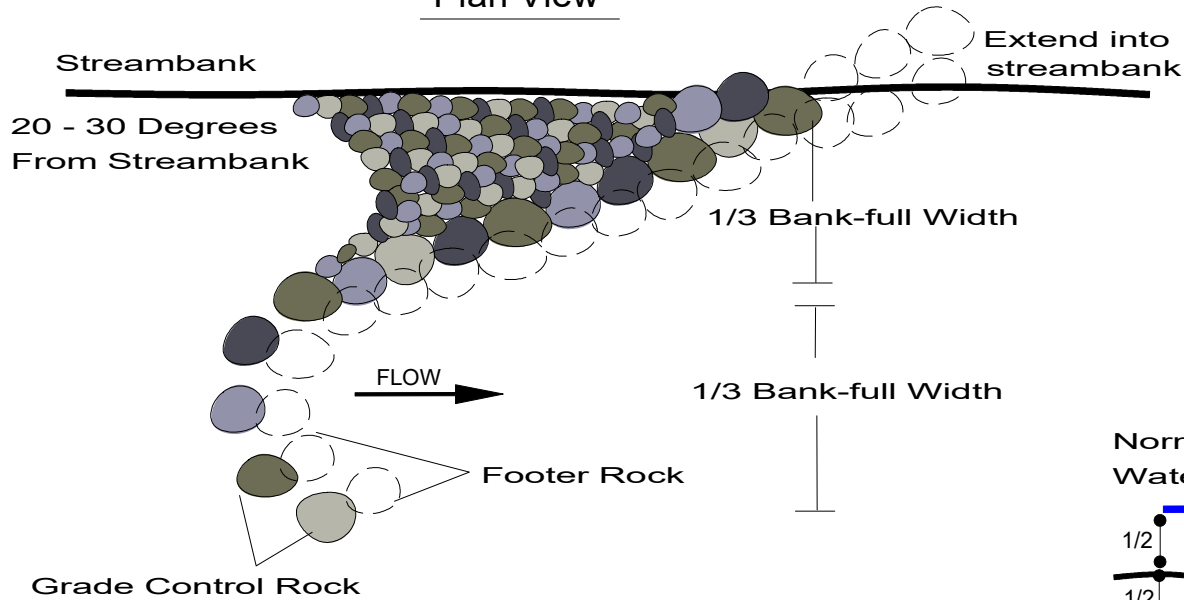

Section View

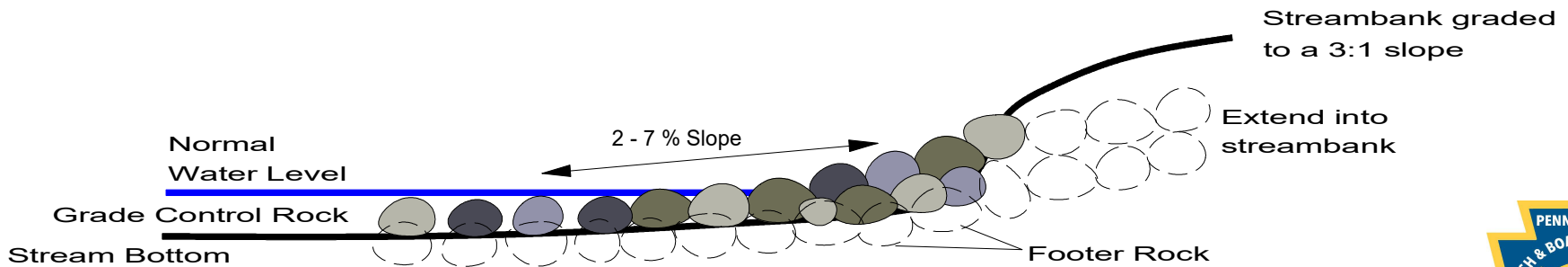

SINGLE LOG VANE DEFLECTOR WITH J-HOOK AND ROOTWAD

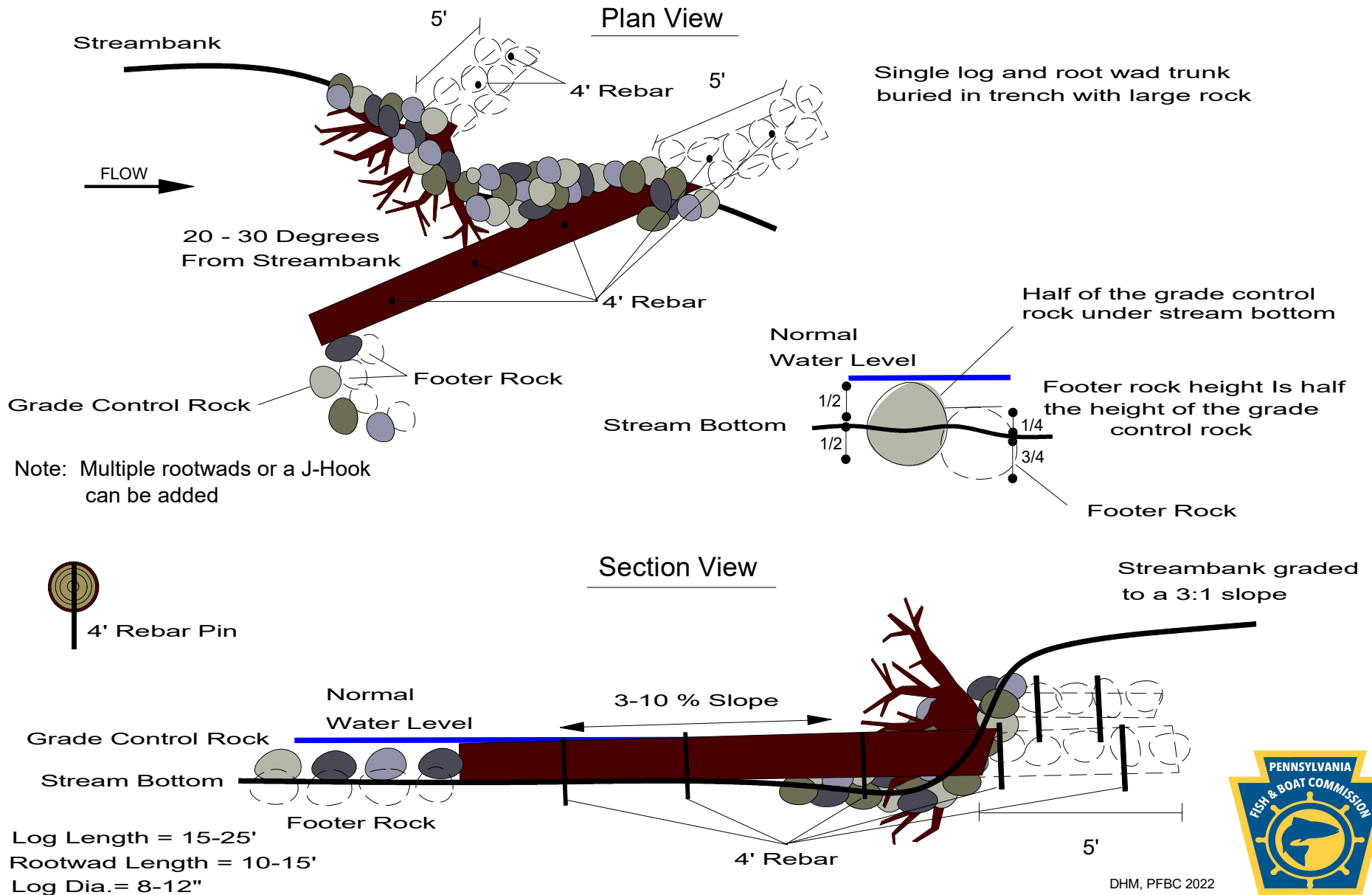

SINGLE LOG VANE DEFLECTOR WITH J-HOOK

Plan View

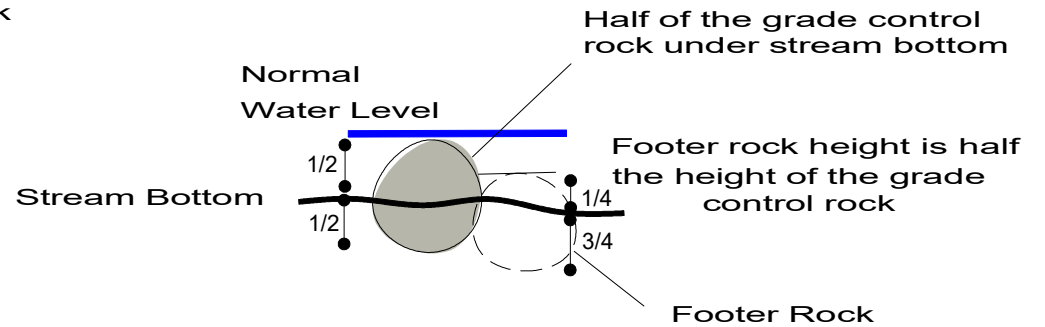
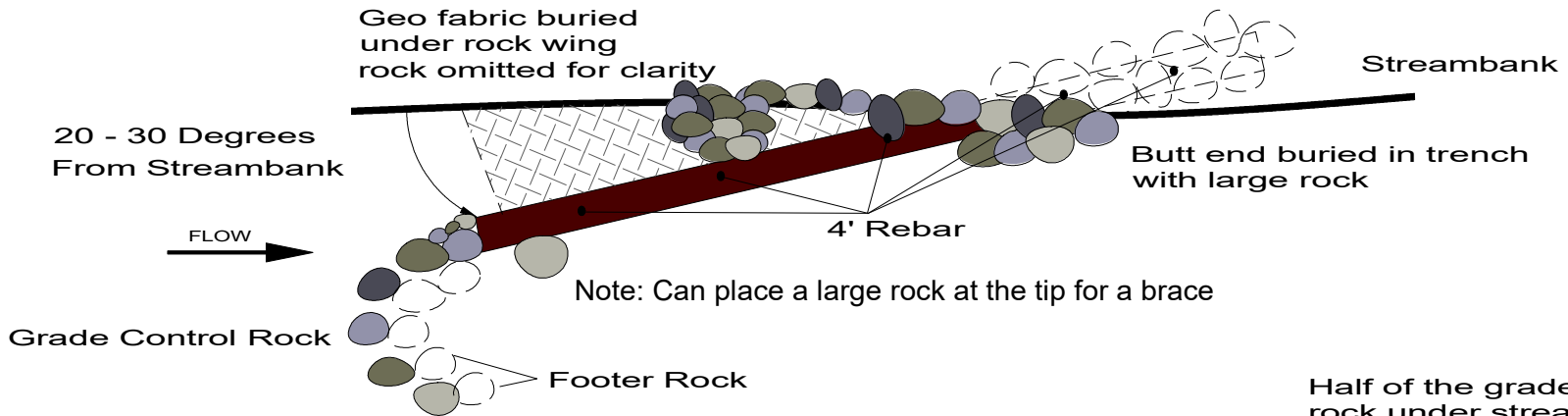

Section View

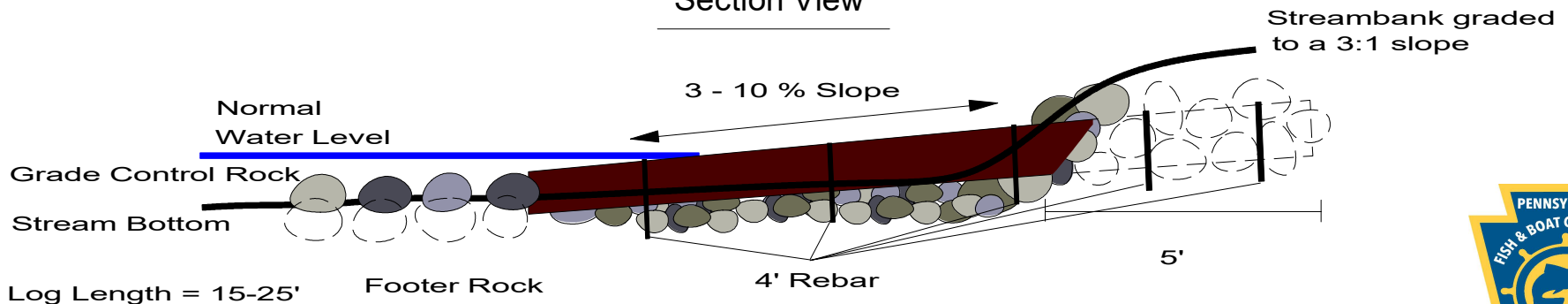

SINGLE LOG VANE DEFLECTOR

Plan View

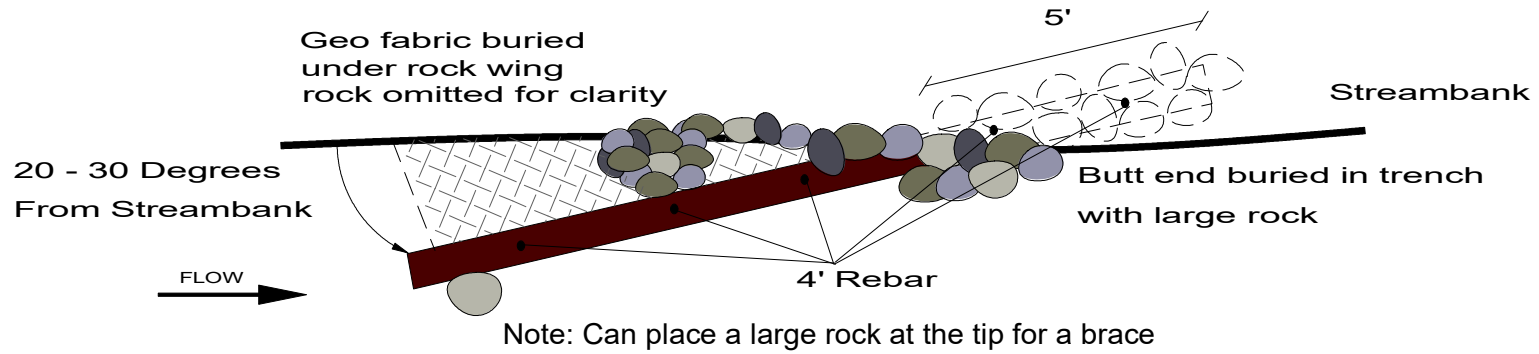

4' Rebar Pin

Section View

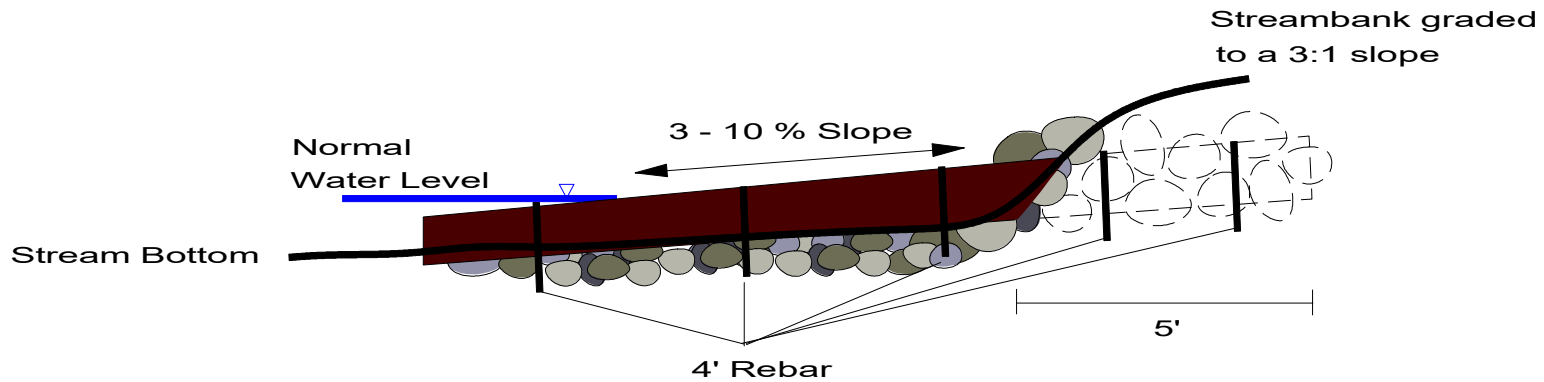

Log Length = 15-25'

Log Dia. = 8-12"

DHM, PFBC 2022

